

15. Back Light .....	47
16. Memory Function .....	48
16.1 How to save the data .....	48
16.2 Recall the saved data .....	50
16.3 Delete the saved data .....	51
16.4 Transfer the stored data to PC .....	53
17. General .....	54
18. Battery replacement .....	55
19. Fuse replacement .....	55
20. Servicing and Calibration .....	56
21. Pat test with the Pat adapter 1 .....	57
22. Zs tables .....	58
23. Case and strap assembly .....	60

The KT65DL incorporates Anti Trip Technology (ATT) which electronically bypasses RCDs when performing loop impedance tests. This saves time and money by not having to take the RCD out of the circuit during testing and is a safer procedure to follow.

With the ATT function enabled, a test of 15mA or less is applied between line & earth. It enables loop impedance measurements without tripping RCDs rated at 30mA and above.

Please read this instruction manual carefully before using this equipment.

## 1 Safe Testing

**Electricity is dangerous and can cause injury and death. Always treat it with the greatest of respect and care. If you are not quite sure how to proceed, stop and take advice from a qualified person.**

- 1 This instrument must only be used by a competent and trained person and operated in strict accordance with the instructions. Kewtech will not accept liability for any damage or injury caused by misuse or non-compliance with the instructions or with the safety procedures.
- 2 It is essential to read and to understand the safety rules contained in these instructions. They must always be observed when using the instrument.
- 3 This instrument is designed to work in distribution systems where the line to earth has a maximum voltage of 300V 50/60Hz and for some ranges where line to line has a maximum voltage of 500V 50/60Hz.  
Be sure to use it within this rated voltage.  
For use in the continuity testing and insulation testing modes this instrument **must be used ONLY on circuits which are de-energized.**
- 4 When conducting tests do not touch any exposed metalwork associated with the installation. Such metalwork may become live for the duration of the test.
- 5 **Never open the instrument case** (except for fuse and battery replacement and in this case disconnect all leads first) because dangerous voltages are present. Only fully trained and competent electrical engineers should open the case. If a fault develops, return the instrument to Kewtech for inspection and repair.
- 6 If the overheat symbol appears in the display disconnect the instrument from the mains supply and allow to cool down.
- 7 If abnormal conditions of any sort are noted (such as a faulty display, unexpected readings, broken case, cracked test leads, etc) do not use the tester and return it to Kewtech for repair.
- 8 For safety reasons only use accessories (test leads, probes, fuses, cases, etc) designed to be used with this instrument and recommended by Kewtech. The use of other accessories is prohibited as they are unlikely to have the correct safety features.
- 9 When testing, always be sure to keep your fingers behind the finger guards on the test leads.
- 10 During testing it is possible that there may be a momentary degradation of the reading due to the presence of excessive transients or discharges on the electrical system under test. Should this be observed, the test must be repeated to obtain a correct reading. If in doubt, contact Kewtech.

- 11 Do not operate the function selector whilst the instrument is connected to a circuit. If, for example, the instrument has just completed a continuity test and an insulation test is to follow, disconnect the test leads from the circuit before moving the selector switch.
- 12 Do not rotate rotary switch when test button is depressed. If the function switch is inadvertently moved to a new function when the test button is depressed or in lock-down position the test in progress will be halted.
- 13 Always check the test lead resistance before carrying out tests. This ensures the leads are ok before taking measurements. The resistance of leads and/or crocodile clips may be significant when measuring low resistances. If crocodile clips can be avoided for low resistance measurements, this will reduce the error due to lead accessories
- 14 When carrying out Insulation Resistance tests, always release the test button and wait for charged capacitances to totally discharge before removing the test leads from the test circuit.

## 2 Instrument layout

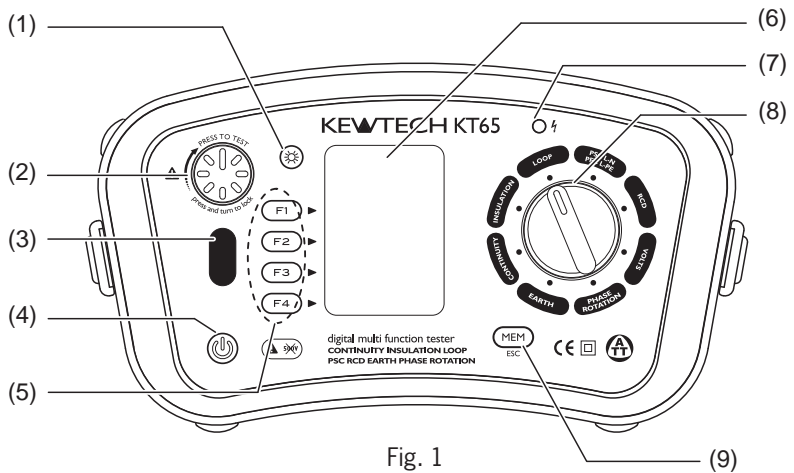

Fig. 1

Name	Operation
(1) Back Light Button	Switches on/off the Backlight of the Display(LCD)
(2) Test Button	Starts measurements. (press and rotate for lock down feature)
(3) Touch Pad	Checks the electrical potential at the PE terminal
(4) Power Switch	Power Switch
(5) Function Switch	Function setting (F1 ~ F4)
(6) Display (LCD)	Dot Matrix LCD 160(W)X240(H)
(7) Insulation resistance LED	Alerts that the test voltage is being output
(8) Rotary Switch	Selects measurement functions.
(9) MEM (ESC) Button	Activates Memory Function, or ESC Key

## Input Terminal

## Instrument layout

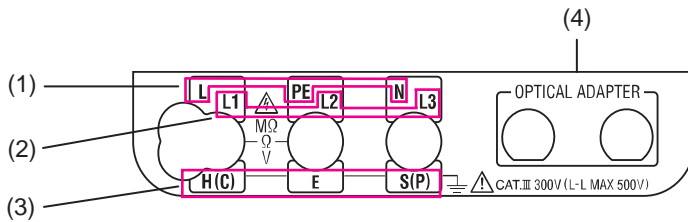
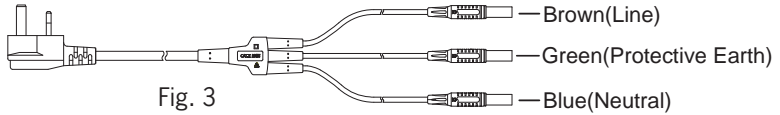

Fig. 2

	Function	Terminal
(1)	Terminal Names for : INSULATION, CONTINUITY LOOP, PFC/PSC, RCD, VOLTS	L : Line PE : Protective Earth N : Neutral (for LOOP,PSC/PFC, RCD)
(2)	Terminal Name for PHASE ROTATION	L1 : Line1 L2 : Line2 L3 : Line3
(3)	Terminal Name for EARTH	H(C) : Terminal for auxiliary earth spike (current) E : Terminal for the earth electrode S(P) : Terminal for auxiliary earth spike (potential)
(4)	Optical Adapter	Communication port for Model8212USB

### 3 Accessories

#### 1. Main Test Lead (KAMP12)



#### 2. Remote Test Lead (ACC064SP)

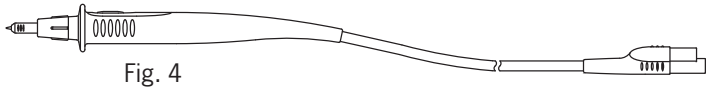

#### 3. Distribution Board Test Lead (ACC065)

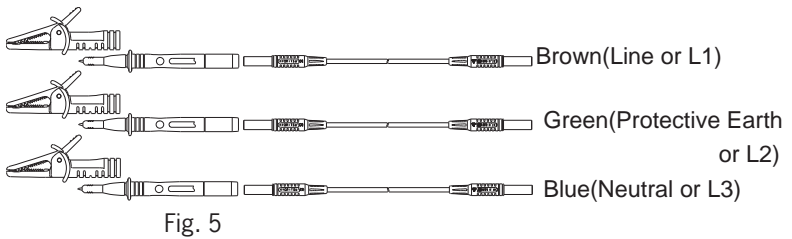

4. Test Lead Carry pouch···x1
5. Carrying Bag···x1
6. Instruction Manual···x1
7. Shoulder Strap···x1
8. Buckle···x2
9. Battery···x8
10. Optional Accessory

- PAT ADAPTER - See Page57
- Earth Tests Lead(Model7228) and Auxiliary Earth Spikes

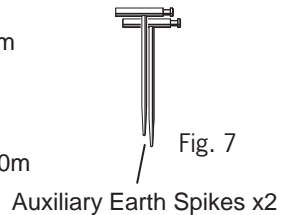
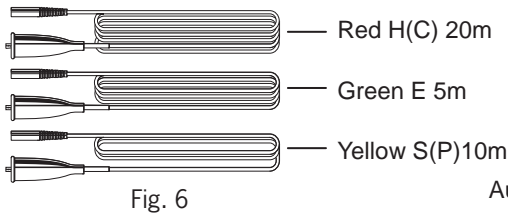

- Model8212USB with PC Software “KEW Report”.

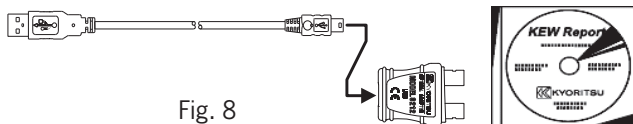

The KT65DL Multi-Function tester performs eight functions in one instrument.

- 1 Continuity
- 2 Insulation resistance
- 3 Loop impedance
- 4 Prospective short circuit current
- 5 RCD
- 6 Voltage
- 7 Phase rotation
- 8 Earth resistance

Continuity function has the following features:

- |                      |                                                                                                                                                                                  |
|----------------------|----------------------------------------------------------------------------------------------------------------------------------------------------------------------------------|
| Live circuit warning | “Live Circuit” warning on the display.                                                                                                                                           |
| Fuse Protection      | Continuity Function has a fuse protection function to prevent a fuse blow at live working. With this function, a fuse rarely blow while measuring continuity on live conductors. |
| Continuity Null      | Allows automatic subtraction of test lead resistance from continuity measurements.                                                                                               |
| Continuity 2Ω Buzzer | Buzzer sounds at 2Ω or less at Continuity function. (Switchable on or off)                                                                                                       |

Insulation function has the following features:

- |                           |                                                                                                                         |
|---------------------------|-------------------------------------------------------------------------------------------------------------------------|
| Live circuit warning      | “Live Circuit” warning on the display.                                                                                  |
| Auto discharge            | Electric charges stored in capacitive circuits are discharged automatically after testing by releasing the test button. |
| Insulation Resistance LED | LED lights up while making measurements at Insulation function and alerts that test voltage is being output.            |

Loop impedance, PSC/PFC and RCD testing functions have the following features:

- |                             |                                                                                                                                                                                                                    |
|-----------------------------|--------------------------------------------------------------------------------------------------------------------------------------------------------------------------------------------------------------------|
| Wiring check                | Three Wiring symbols indicate if the wiring of the circuit under test is correct.                                                                                                                                  |
| Over temperature protection | Detects overheating of the internal resistor (used for LOOP and PSC/PFC tests) and of the current control MOS FET (used for RCD tests) displaying a warning symbol and automatically halting further measurements. |
| Phase angle selector        | The test can be selected from either the positive (0 ° ) or from the negative (180 ° ) half cycle of voltage. This selector is used in the RCD mode to                                                             |

## Features

	obtain the maximum trip time of an RCD for the test selected.
UL value selector	Select UL (limit of contact voltage) 25V or 50V. Where $U_c$ (contact voltage) exceeds UL value at RCD testing, " $U_c > UL$ " will be displayed without starting the measurement.
ALL testing functions have the following	
Touch Pad	Gives an alert, when touching the Touch Pad, while the PE terminal is connected to Line by mistake.
Memory Function	Save the measured data in the internal memory. The data can be edited on a PC by using Communication Adapter Model8212USB and PC Software "KEW Report".
Auto power off	Automatically switches the instrument off after a period of approximately 10 minutes. The Auto power off mode can only be cancelled by switching the instrument on again.



## 5.1 Measurement Specification

### Continuity

Open Circuit Voltage (DC)	Short Circuit Current	Range	Accuracy
5V±20%(*1)	Greater than 200mA	20/200/2000Ω	0~0.19Ω ±0.1Ω
		Auto-Ranging	0.2~2000Ω ±(2%rdg+8dgt)

2Ω Buzzer : Buzzer sounds when measured resistance is 2Ω or less.

2Ω Buzzer Accuracy : 2Ω±0.4Ω

(\*1) Voltages are output when measurement resistance is under 2100 ohm.

### Insulation Resistance

Open Circuit Voltage (DC)	Rated Current	Range	Accuracy
250V+25% -0%	1mA or greater @ 250kΩ	20/200MΩ	0~19.99MΩ : ±(2%rdg+6dgt)
		Auto-Ranging	20~200MΩ : ±(5%rdg+6dgt)
500V+25% -0%	1mA or greater @ 500kΩ	20/200/1000MΩ	0~199.9MΩ : ±(2%rdg+6dgt)
		Auto-Ranging	200~1000MΩ : ±(5%rdg+6dgt)
1000V+20% -0%	1mA or greater @ 1MΩ	20/200/2000MΩ	0~199.9MΩ : ±(2%rdg+6dgt)
		Auto-Ranging	200~2000MΩ : ±(5%rdg+6dgt)

## 5 Specification

## Specification

### Loop Impedance

Function	Rated Voltage	Nominal Test Current at 0Ω External Loop: Magnitude/Duration(*2)	Range	Accuracy
0.01 ΩRes	50~260V 50/60Hz	20Ω: 6A/20ms 200Ω: 2A/20ms 2000Ω: 15mA/500ms	20/200/2000Ω Auto-Ranging	±(3%rdg+4dgt) *3 ±(5%rdg+15dgt) *4 ±(3%rdg+8dgt) *5
L-PE	0.001 ΩRes 230V +10%-15% 50/60Hz	2Ω: 6A/90ms	2Ω	±(3%rdg+35mΩ)
L-PE (ATT)	100~260V 50/60Hz	L-N: 6A/60ms N-PE: 10mA/ approx. 5s	20/200/2000Ω Auto-Ranging (L-N < 20Ω)	±(3%rdg+6dgt) *3 ±(3%rdg+8dgt) *4
L-N / L-L	50/60Hz L-N:50~300V L-L:300~500V	20Ω: 6A/20ms	20Ω	±(3%rdg+4dgt) *3 ±(5%rdg+15dgt) *4 ±(3%rdg+8dgt) *5

\*2: at 230V

\*3: 230V+10%-15%

\*4: 50V~100V

\*5: voltages except for \*3 and \*4

### PSC (L-N/L-L) / PFC (L-PE)

Function	Rated Voltage	Nominal Test Current at 0Ω External Loop: Magnitude/Duration(*6)	Range	Accuracy
PSC	50~500V 50/60Hz	6A/20ms		PSC/PFC accuracy is derived from measured loop impedance specification and measured voltage specification
PFC	50~260V 50/60Hz	6A/20ms 2A/20ms 15mA/500ms	2000A/20kA Auto-Ranging	
PFC (ATT)	100~260V 50/60Hz	L-N: 6A/60ms N-PE: 10mA/ approx. 5s		

\*6: at 230V

RCD

Specification

Function	Rated Voltage	Accuracy		
		Trip Current		Trip Time
		AC Type	A Type	
X1/2	230V+10%-15%	-8%~-2%	-10%~0%	±(1%rdg+3dgt)
X1		+2%~+8%	0%~+10%	
X5		+2%~+8%	0%~+10%	
Ramp(▲)	±4%	± 10%		
Auto	Depending on the accuracy at each function. Measurement sequence: X1/2 0°→X1/2 180°→X1 0°→X1 180°→X5 0°→X5 180° Measurements with x5 are not carried out for RCDs with nominal current of 100mA or more.			



RCD Trip Current Duration

Function	Type	RCD Trip Current Duration							
		10	30	100	300	500	1000		
Trip Current Duration (ms)	X1/2	G	AC	2000	2000	2000	2000	2000	2000
			A	2000	2000	2000	2000	2000	n.a
		S	AC	2000	2000	2000	2000	2000	n.a
			A	2000	2000	2000	2000	2000	n.a
	X1	G	AC	550	550	550	550	550	550
			A	550	550	550	550	550	n.a
		S	AC	1000	1000	1000	1000	1000	n.a
			A	1000	1000	1000	1000	1000	n.a
	X5	G	AC	410	410	410	n.a	n.a	n.a
			A	410	410	410	n.a	n.a	n.a
		S	AC	410	410	410	n.a	n.a	n.a
			A	410	410	410	n.a	n.a	n.a
Ramp (▲)	G	AC	Goes up by 10% from 20% to 110%					n.a	
		A	300ms×10 times					n.a	
	S	AC	Goes up by 10% from 20% to 110%					n.a	
		A	500ms×10 times					n.a	

Earth

Measuring Frequency	Range	Accuracy
825Hz	20/200/2000Ω Auto-Ranging	20Ω range : ±(3%rdg+0.1Ω) 200/2000Ω range : ±(3%rdg+3dgt) (Auxiliary earth resistance 100±5%)

**Specification****PHASE ROTATION**

Rated Voltage	Remarks
50-500V	Correct phase sequence: are displayed “1.2.3” and  mark
50/60Hz	Reversed phase sequence: are displayed “3.2.1” and  mark

Volts

Function	Rated voltage	Measuring Range	Accuracy
Volts	25~500V 45~65Hz	25~500V	±(2%rdg+4dgt)
Frequency	25~500V 45~65Hz	45~65Hz	±(0.5%rdg+2dgt)

Possible number of tests with fresh batteries.

Continuity	: Approx. 2000 times min. at load 1 Ω
Insulation Resistance	: Approx. 1000 times min. at load 1MΩ (1000V)
LOOP/PFC/PSC	: Approx. 1000 times min. (ATT)
RCD	: Approx. 2000 times min. (G-AC X1 30mA)
EARTH	: Approx. 1000 times min. at load 10 Ω
VOLT/PHASE ROTATION	: Approx. 50H

Reference Conditions

Ambient temperature	23±5°C
Relative humidity	45% to 75%
Nominal system voltage and frequency	230V, 50Hz
Altitude	Less than 2000m

**5.2 Operating error**

Continuity (EN61557-4)

Operating range compliant with EN61557-4 operating error	Maximum percentage operating error
0.20~1999MΩ	±30%

The influencing variations used for calculating the operating error are denoted as follows;

Temperature	: 0°C and 35°C
Supply voltage	: 8V to 13.8V

Insulation Resistance(EN61557-2)

Specification

Volt	Operating range compliant with EN61557-2 operating error	Maximum percentage operating error
250V	0.25~199.9MΩ	±30%
500V	0.50~999MΩ	
1000V	1.00~1999MΩ	

The influencing variations used for calculating the operating error are denoted as follows;

Temperature : 0°C and 35 °C

Supply voltage : 8V to 13.8V

Loop Impedance(EN61557-3)

Volt	Operating range compliant with EN61557-3 operating error	Maximum percentage operating error
L-PE	0.40~1999Ω (0.001 Ω Res:0.400~1.999Ω)	±30%
L-N	0.40~19.99Ω	

The influencing variations used for calculating the operating error are denoted as follows;

Temperature : 0 °C and 35 °C

Phase angle : At a phase angle 0° to 18°

System frequency : 49.5Hz to 50.5Hz

System voltage : 230V+10%-15%

Supply voltage : 8V to 13.8V

Harmonics : 5% of 3<sup>rd</sup> harmonic at 0° phase angle, 5% of 5th harmonic at 180° phase angle, 5% of 7th harmonic at 0° phase angle

D.C quantity : 0.5% of the nominal voltage

RCD(EN61557-6)

Function	Operating error of trip current
X1/2	-10%~0%
X1, X5	0%~+10%
Ramp	-10%~+10%

The influencing variations used for calculating the operating error are denoted as follows;

Temperature : 0 °C and 35 °C

Earth electrode Resistance (shall not exceed below) :

IΔn (mA)	Earth electrode resistance (Ω max.)	
	UL50V	UL25V
10	2000	2000
30	600	600
100	200	200
300	130	65
500	80	40
1000	40	20

Table.1

System voltage : 230V+10%-15%

Supply voltage : 8V to 13.8V

## Specification

Earth Resistance (EN61557-5)

Operating range compliant with EN61557-5 operating error	Maximum percentage operating error
5.00~1999Ω	±30%

The influencing variations used for calculating the operating error are denoted as follows;

Temperature	: 0 °C and 35°C
Series interference voltage	: 3V
Resistance of the probes and auxiliary earth electrode resistance	: 100 x RA, 50kΩ or less
Supply voltage	: 8V to 13.8V

### 5.3 General specification

**Instrument dimensions** 235 X 136 X 114mm

**Instrument weight:-** 1350g (including batteries.)

**Reference conditions** **Specifications are based on the following conditions, except where otherwise stated:-**

1. Ambient temperature: 23±5° C:
2. Relative humidity 45% to 75%
3. Position: horizontal
4. AC power source 230V, 50Hz
5. DC power source: 12.0 V, ripple content 1% or less
6. Altitude up to 2000m, Indoor use

**Battery type** Eight LR6,AA or R6 batteries.

**Operating temperature and humidity.** 0 to +40 °C , relative humidity 80% or less, no condensation

**Storage temperature and humidity** -20 to +60°C , relative humidity 75% or less, no condensation.

**Display** Dot Matrix LCD 160(W) X 240(H) pixels.

**Overload protection** The continuity test circuit is protected by a 0.5A/600V fast acting (HRC) ceramic fuse mounted in the battery compartment, where a spare fuse is also stored.





The insulation resistance test circuit is protected by a resistor against 1000 V AC for 10 seconds.

## 5.4 Applied standards







<b>Instrument operating Standard</b>	IEC/EN61557-1,2,3,4,5,6,7,10
<b>Safety standard</b>	IEC/EN 61010-1(2001), CATIII (300V) -Instrument IEC/EN 61010-031(2008) CATII (250V)-Test Lead KAMP12 CATIII (600V)-Test Lead ACC065 CATIII (1000V)-Test Lead ACC064SP CATIII (300V)-Test Lead Model7228
<b>Protection degree</b>	IEC 60529 (1989 + A1) IP40
<b>EMC</b>	EN 61326 EN55022/24

## Specification

This manual and product may use the following symbols adopted from International Safety Standards;

- CAT.III Measurement category “CAT III” applies to;  
Primary electrical circuits of the equipment connected directly to the distribution panel, and feeders from the distribution panel to outlets.
-  Equipment protected throughout by DOUBLE INSULATION or REINFORCED INSULATION;
-  Caution (refer to accompanying documents)
-  Caution, risk of electric shock
-  Protection against wrong connection is up to 500V
-  Earth Ground

## 5.5 List of Display Message

 B	Low battery warning
	Temperature monitor for internal resistance, available at Loop, PSC/PFC & RCD function. Further measurements are suspended until the  symbol disappears.
Measuring	Measurements in progress
Live Circuit	Live circuit warning (Continuity / Insulation Function)
PE Hi V	Caution : Presence of 100V or more at PE terminal, appears when touching the Touch Pad
L-N >20Ω	Alert : Presence of 20Ω or more between Line - Neutral at ATT measurement
Noise	Caution : Presence of noise in the circuit under test during ATT measurement. ATT function should be disabled to continue measurements.
N - PE Hi V	Caution: Presence of high voltage between NEUTRAL - EARTH during ATT measurement. ATT function should be disabled to continue measurements.
Uc > UL	Caution : Uc at RCD measurement is exceeding the preset UL value (25 or 50V).
no	Error message : When on the RCD function, RCD tripped before measuring RCD trip time. Selected IΔn value may not be correct. When on the LOOP, PSC/PFC function, supply may have been interrupted.
L-PE ● L-N ●  ○	Wiring check for LOOP, PSC/PFC function
 OK	Appears when all results passed during the RCD Auto Test function.
 NO	Appears when any results failed during the RCD Auto Test function.
R <sub>H</sub> Hi, R <sub>S</sub> Hi	Appears when a Probe resistance of H terminal (R <sub>H</sub> ) or of S terminal (R <sub>S</sub> ) at Earth measurement is exceeded the measurable range.
No 3-phase system	Appears to indicate wrong connection at Phase Rotation check.



Setting for following three parameters

- ▲ UL value.....Selects a UL value for RCD function
- ▲ Touch Pad.....Enables / disables Touch Pad function
- ▲ Back Light.....Selects Backlight ON / OFF. When ON is selected, the Backlight automatically turns on at powering on the instrument.

Setting method

1. Press the Config Button (F4) when powering on KT65. (Fig.9)

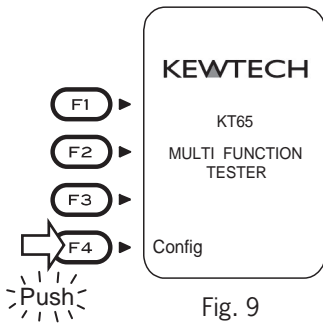

Fig. 9

2. Then, Configuration Screen (Fig.10) is displayed.

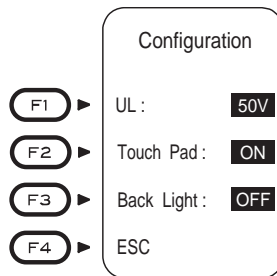

Fig. 10

3. Press the F1 – F3 Button to change following setting.

	Parameter	Selection	Initial value
F1	UL value	25V, 50V	50V
F2	Touch Pad	ON, OFF	ON
F3	Back Light	ON, OFF	OFF

4. Press the ESC Button (F4) when setting change is completed, and return to the normal screen.

## 7 Continuity

**Warning: Ensure that circuits to be tested are not live.**

**Disconnect the instrument from the circuit under test before operating the function switch.**

**To select the low resistance range select 'CONTINUITY' .**

### 7.1 Test Procedure

The object of continuity testing is to measure only the resistance of the parts of the wiring system under test. This measurement should not include the resistance of any test leads used. The resistance of the test leads needs to be subtracted from any continuity measurement. The KT65DL is provided with a continuity null feature which allows automatic compensation for any test lead resistance.

**You should only use the test leads supplied with the instrument.**

### Operation of Function Switch

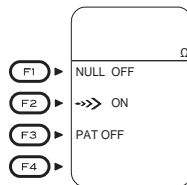

Fig. 11

F1 Switches on / off NULL function

F2 Switches on / off 2 Ω buzzer

F3 PAT mode setting.  
(PAT OFF, CL1 0.1 Ω, CL1 0.3 Ω)

F4 N/A

Proceed as follows:-

- 1 Select the continuity test by rotating the Rotary switch.
- 2 Press F3 switch to select PAT mode setting.
- 3 Insert the Test Leads to the L and PE terminal on KT65DL respectively as shown in Fig.12.

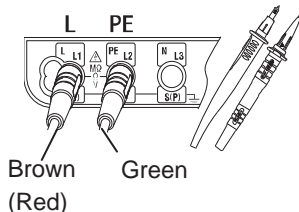

Fig. 12

L terminal

Brown cord of ACC065, or  
ACC064SP Remote Test Lead

PE terminal

Green cord of ACC065

- 4 Connect the ends of the test leads firmly together (see Fig.13) and press and lock down the test button. The value of the lead resistance will be displayed.

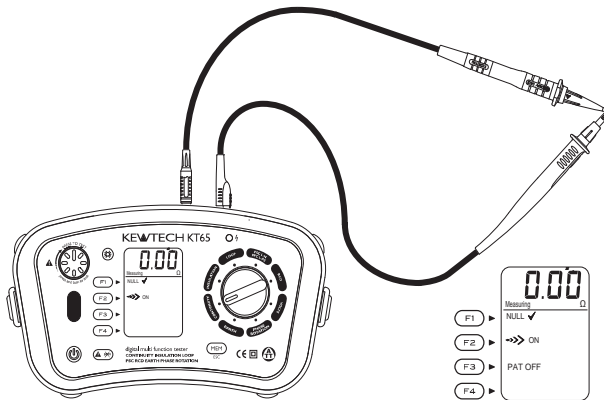

Fig. 13

- 5 Press the Continuity Null (F1) button, this will null out the lead resistance and the indicated reading should go to zero.
- 6 Release the test button. Press the test button and ensure the display reads zero before proceeding. While using the Continuity null function, “NULL ✓” is displayed on the LCD as indicated in Fig.13. The null value will be stored even if the instrument is powered off. This memorised null value can be cancelled by disconnecting the test leads and pushing the Continuity Null button (F1) with the test button pressed or locked. When this is cancelled you will know because NULL OFF is displayed on the LCD.  
CAUTION - before taking any measurements always check the leads have been zeroed.
- 7 Connect the test leads to the circuit whose resistance is required (see Fig.14 for a typical connection arrangement), having first made sure **that the circuit is not live**. Note that “Live Circuit” warning will be displayed on the LCD if the circuit is live - but check first anyway!
- 8 Press the test button and read the circuit resistance from the display. The reading will have the test lead resistance already subtracted if the Continuity null function has been used.
- 9 Note that if the circuit resistance is greater than  $20\Omega$  the instrument will autorange to the  $200\Omega$ , if it is greater than  $200\Omega$  it will autorange to the  $2000\Omega$  range.

**Note: If the reading is greater than  $2000\Omega$  the overrange symbol ‘>’ will remain displayed.**

The results of measurements can be adversely affected by impedances of additional operating circuits connected in parallel or by transient currents.

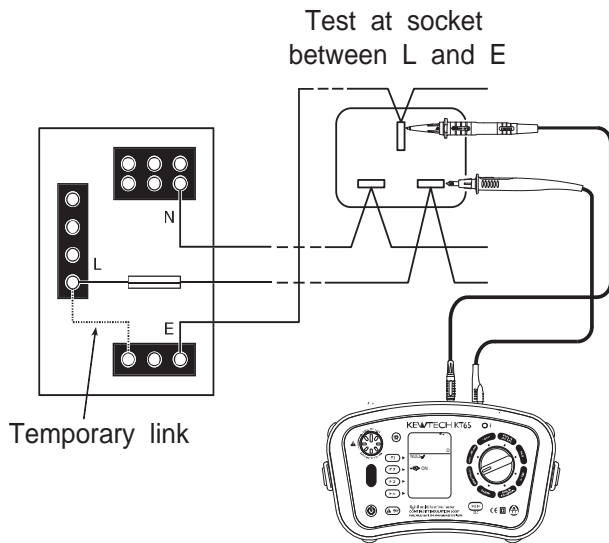

Fig. 14

- ▲ If PAT mode is selected, pass(✓) or fail(X) mark is displayed during measurement. Pass or fail mark is displayed on LCD according to the following table.

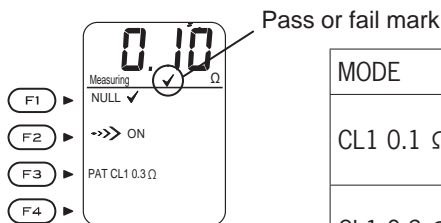

Fig. 15

MODE	Measured Value	Result
CL1 0.1 Ω	Less than 0.1 Ω	Pass (✓)
	Over 0.1 Ω	Fail (X)
CL1 0.3 Ω	Less than 0.3 Ω	Pass (✓)
	Over 0.3 Ω	Fail (X)

### 7.2 2Ω Buzzer ( ) function

Use F2 Button to enable / disable the 2Ω Buzzer. The Buzzer sounds when measured resistance is 2Ω or less while this function is enabled. Buzzer does not sound if it is disabled.

**Warning: Ensure that circuits to be tested are not live.**

**Disconnect the instrument from the circuit under test before operating the function switch.**

**To select the insulation resistance range select 'INSULATION' .**

### 8.1.1 The nature of insulation resistance

Live conductors are separated from each other and from earth by insulation, which has a resistance which is high enough to ensure that the current between conductors and to earth is kept at an acceptably low level. Ideally insulation resistance is infinite and no current should be able to flow through it. In practice, there will normally be a current between live conductors and to earth, this is known as leakage current. This current is made up of three components, which are:-

1. capacitive current
2. conduction current, and
3. surface leakage current.

### 8.1.2 Capacitive Current

The insulation between conductors which have a potential difference between them behaves as the dielectric of a capacitor, the conductors acting as the capacitor plates. When a direct voltage is applied to the conductors, a charging current will flow to the system which will die away to zero (usually in less than a second) when the effective capacitor becomes charged. This charge must be removed from the system at the end of the test, a function which is automatically performed by the KT65DL. If an alternating voltage is applied between the conductors, the system continuously charges and discharges as the applied voltage alternates, so that there is a continuous alternating leakage current flowing to the system.

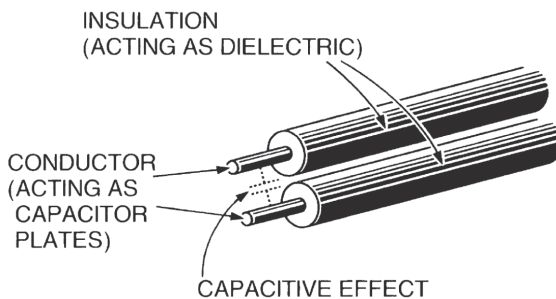

Fig. 16

**8.1.3 Conduction Current**

Since the insulation resistance is not infinite, a small leakage current flows through the insulation between conductors. Since Ohm's Law applies, the leakage current can be calculated from

$$\text{Leakage current } (\mu A) = \frac{\text{applied voltage (V)}}{\text{insulation resistance (M}\Omega)}$$

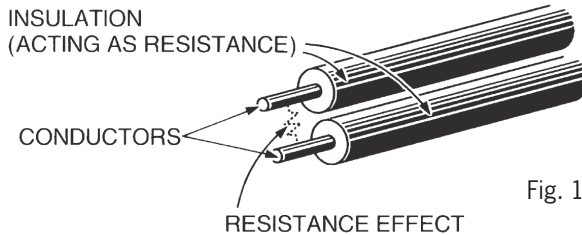

Fig. 17

**8.1.4 Surface Leakage Current**

Where insulation is removed, for the connection of conductors and so on, current will flow across the surfaces of the insulation between the bare conductors. The amount of leakage current depends on the condition of the surfaces of the insulation between the conductors. If the surfaces are clean and dry, the value of the leakage current will be very small. Where the surfaces are wet and/or dirty, the surface leakage current may be significant. If it becomes large enough, it may constitute a flashover between the conductors.

Whether this happens depends on the condition of the insulation surfaces and on the applied voltage; this is why insulation tests are carried out at higher voltages than those normally applying to the circuit concerned.

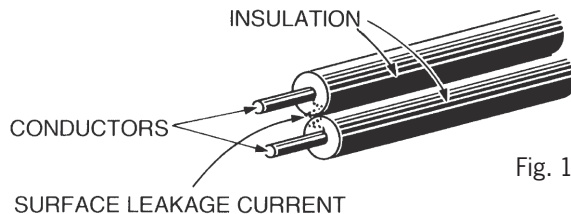

Fig. 18

**8.1.5 Total Leakage Current**

The total leakage current is the sum of the capacitive, conduction and surface leakage current described above. Each of the currents, and hence the total leakage current, is affected by factors such as ambient temperature, conductor temperature, humidity and the applied voltage.

If the circuit has alternating voltage applied, the capacitive current (8.1.2) will

always be present and can never be eliminated. This is why a direct voltage is used for insulation resistance measurement, the leakage current in this case quickly falling to zero so that it has no effect on the measurement. A high voltage is used because this will often break down poor insulation and cause flashover due to surface leakage (see 8.1.4), thus showing up potential faults which would not be present at lower levels.

The insulation tester measures the applied voltage level and the leakage current through the insulation. These values are internally calculated to give the insulation resistance using the expression:-

$$\text{Insulation resistance (M}\Omega\text{)} = \frac{\text{Test voltage (V)}}{\text{Leakage current (}\mu\text{A)}}$$

As the capacitance of the system charges up, so the charging current falls to zero and a steady insulation resistance reading indicates that the capacitance of the system is fully charged. The system is charged to the full test voltage, and will be dangerous if left with this charge. The KT65DL provides an automatic path for discharging current as soon as the test button is released to ensure that the circuit under test is safely discharged.

If the wiring system is wet and/or dirty, the surface leakage component of the leakage current will be high, resulting in low insulation resistance reading. In the case of a very large electrical installation, all the individual circuit insulation resistances are effectively in parallel and the overall resistance reading will be low. The greater the number of circuits connected in parallel the lower will be the overall insulation resistance.

## 8.2 Damage to Voltage-Sensitive Equipment

An increasing number of electronic-based items of equipment are being connected to electrical installations. The solid state circuits in such equipment are likely to be damaged by the application of the levels of voltage used to test insulation resistance. To prevent such damage, it is important that voltage-sensitive equipment is disconnected from the installation before the test is carried out and reconnected again immediately afterwards. The devices which may need to be disconnected before the test include:-

- ▲ Electronic fluorescent starter switches
- ▲ Passive infra-red detectors (PIRs)
- ▲ Dimmer switches
- ▲ Touch switches
- ▲ Delay timers
- ▲ Power controllers
- ▲ Emergency lighting units
- ▲ Electronic RCDs

## Insulation

- ▲ Computers and printers
- ▲ Electronic point-of-sale terminals (cash registers)
- ▲ Any other device which includes electronic components.

### 8.3 Preparation for measurement

Before testing, always check the following:-

- 1 The 'low battery' Indication is not displayed
- 2 There is no visually obvious damage to the tester or to the test leads
- 3 Test the continuity of the test leads by switching to continuity test and shorting out the lead ends. A high reading will indicate that there is a faulty lead or that the fuse is blown.
- 4 **Make sure the circuit to be tested is not live.** "Live Circuit" warning is displayed if the instrument is connected to a live circuit but test the circuit as well!

### Operation of Function Switch

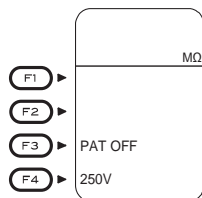

Fig. 19

F1 N/A

F2 N/A

F3 PAT mode setting.  
(PAT OFF, CL1, CL2)

F4 Voltage setting

### 8.4 Insulation resistance measurement

The KT65DL has three selectable test voltages of 250V, 500V and 1000V DC.

- 1 Select INSULATION function with the Rotary switch.
- 2 Press the VOLT Switch (F4) and select desirable voltage range.
- 3 Press F3 switch to select PAT mode setting.  
(In case of 1000V range, PAT mode is not selectable.)
- 4 Insert the Test Leads to the L and PE terminal on the KT65DL respectively as shown in Fig.20.

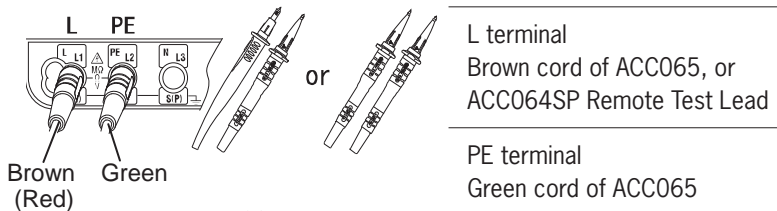

Fig. 20

L terminal

Brown cord of ACC065, or  
ACC064SP Remote Test Lead

PE terminal

Green cord of ACC065



5 Attach the test leads to the circuit or the appliance under test (see Figs 21 & 22)

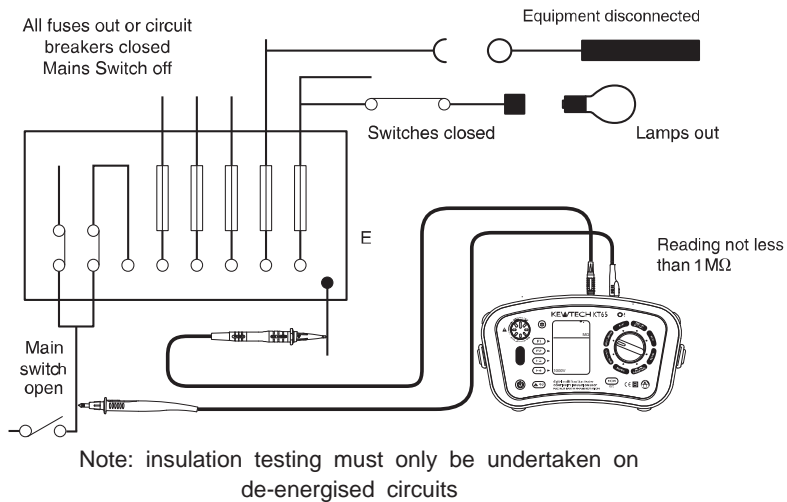

Fig. 21

6 If the “Live Circuit” warning is displayed on the LCD and/or the buzzer sounds, **do not press the test button** but disconnect the instrument from the circuit. Make the circuit dead before proceeding.

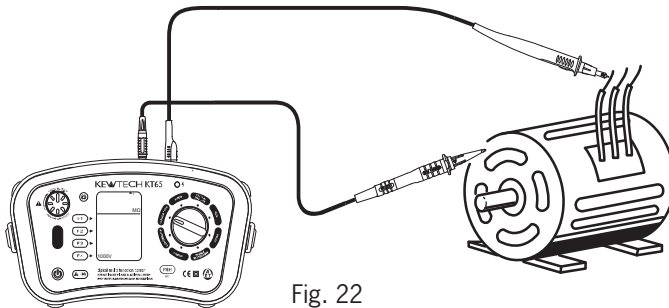

Fig. 22

7 Press the test button, the display will show the insulation resistance of the circuit or the appliance to which the instrument is connected.

8 Note that if the circuit resistance is greater than 20MΩ, the instrument will autorange to the 200MΩ range. If it is greater than 200MΩ at the 500V or 1000V range, it will autorange to the 2000MΩ range. If it is greater than 200MΩ at the 500V range, it will autorange to the 1000MΩ range. If it is greater than 200MΩ at the 1000V range, it will autorange to the 2000MΩ range.

9 When testing is complete release the test button before disconnecting the test leads from the circuit or from the appliance. This will ensure that the charge built up by the circuit or the appliance during insulation test is

## Insulation

dissipated in the discharge circuit. In the discharging process, “Live Circuit” warning will be displayed on the LCD and the live circuit warning buzzer will sound.

- ▲ If PAT mode is selected, pass(✓) or fail(X) mark is displayed during measurement. Pass or fail mark is displayed on LCD according to the following table.

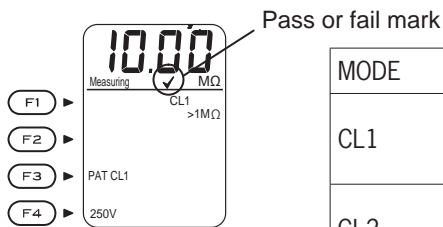

Fig. 23

MODE	Measured Value	Result
CL1	Over 1M Ω	Pass (✓)
	Less than 1M Ω	Fail (X)
CL2	Over 2M Ω	Pass (✓)
	Less than 2M Ω	Fail (X)

### WARNING

Never touch the circuit, test lead tips or the appliance under test during insulation testing because high voltages exist.

### CAUTION

Never turn the Rotary switch whilst the test button is depressed as this may damage the instrument.

Always release the test button first after testing before removing the test leads from the circuit. This is to ensure that charges stored in the circuit capacitance have been totally discharged.

**Note:** If the reading measured greater than 2000MΩ (200MΩ at 250V 1000MΩ at 500V) the over range reading ‘>’ will be displayed.

### 9.1 Principles of measurement of fault loop impedance and PFC

If an electrical installation is protected by over-current protective devices including circuit breakers or fuses, the earth loop impedance should be measured.

In the event of a fault the earth fault loop impedance should be low enough (and the prospective fault current high enough) to allow automatic disconnection of the electrical supply by the circuit protection device within a prescribed time interval. Every circuit must be tested to ensure that the earth fault loop impedance value does not exceed that specified or appropriate for the over-current protective device installed in the circuit. The KT65DL takes a current from the supply and measures the difference between the unloaded and loaded supply voltages. From this difference it is possible to calculate the loop resistance.

#### TT System

For a TT system the earth fault loop impedance is the sum of the following impedances;

- ▲ Impedance of the power transformer secondary winding.
- ▲ Impedance of the phase conductor resistance from the power transformer to the location of the fault.
- ▲ The impedance of the protective conductor from the fault location to the earth system.
- ▲ Resistance of the local earth system ( $R$ ).
- ▲ Resistance of the power transformer earth system ( $R_0$ ).

The figure below shows (dotted line) the Fault loop impedance for TT systems.

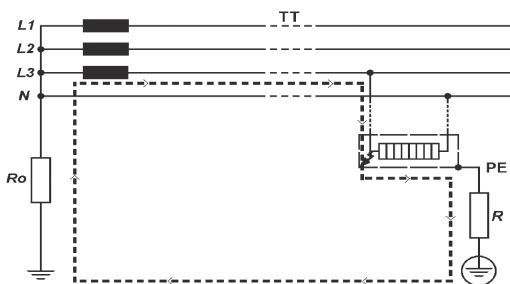

Fig. 24

**LOOP/PSC/PFC**

According to the International Standard IEC 60364, for TT systems the characteristics of the protective device and the circuit resistance shall fulfill the following requirements:

$$R_a \times I_a \leq 50V$$

Where:

**R<sub>a</sub>** is the sum of the resistances in Ω of the local earth system and the protective conductor for the exposed conductive parts.

**50** is the maximum safety touch voltage limit (it can be 25V in particular cases like construction sites, agricultural premises, etc.).

**I<sub>a</sub>** is the current causing the automatic disconnection of the protective device within the maximum disconnecting times required by IEC 60364-41:

- 200 ms for final circuits not exceeding 32A (at 230 / 400V AC)
- 1000 ms for distribution circuits and circuits over 32A (at 230 / 400V AC)

The compliance with the above rules shall be verified by:

- 1) Measurement of the resistance R<sub>a</sub> of the local earth system by Loop tester or Earth tester.
- 2) Verification of the characteristics and/or the effectiveness of the RCD associated protective device.

Generally in TT systems, RCDs are used as a protective device and in this case, I<sub>a</sub> is the rated residual operating current I<sub>Δn</sub>. For instance in a TT system protected by a RCD the max R<sub>a</sub> values are:

Rated residual operating current I <sub>Δn</sub>	30	100	300	500	1000	(mA)
RA (with touch voltage of 50V)	1667	500	167	100	50	(Ω)
RA (with touch voltage of 25V)	833	250	83	50	25	(Ω)

Shown below is a practical example of verification of the protection by RCD in a TT system according to the international Standard IEC 60364.

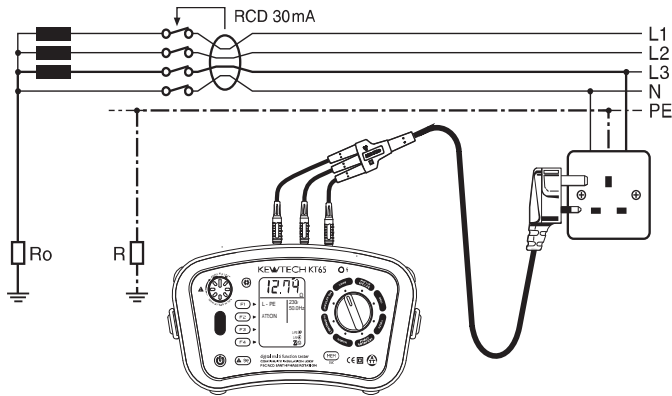

Fig. 25

For this example the max permissible value is  $1667 \Omega$  (RCD =30mA and contact voltage limit of 50 V). The instrument reads  $12.74 \Omega$ , thus the condition  $RA \leq 50/la$  is respected. However, considering that the RCD is essential for protection, it must be tested (Please refer to RCD TESTS section).

### TN System

For TN systems the earth fault loop impedance is the sum of the following impedances.

- ▲ Impedance of the power transformer secondary winding.
- ▲ Impedance of the phase conductor from the power transformer to the location of the fault.
- ▲ Impedance of the protective conductor from the fault location to the power transformer.

The figure below shows (dotted line) the Fault loop impedance for TN systems.

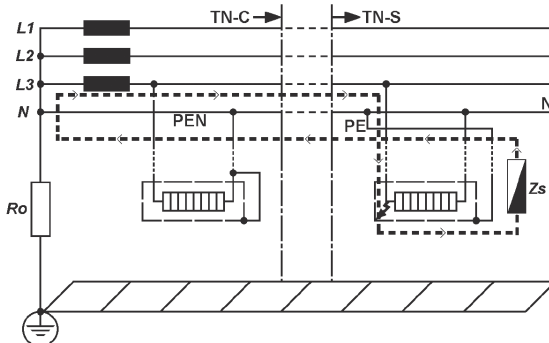

Fig. 26

## LOOP/PSC/PFC

According to the International Standard IEC 60364, for TN system the characteristics of the protective device and the circuit impedance shall fulfill the following requirement:

$$Z_s \times I_a \leq U_o$$

Where:

**Z<sub>s</sub>** is the Fault loop impedance in ohm.

**U<sub>o</sub>** is the nominal voltage between phase to earth (typically 230V AC for both single phase and three phase circuits).

**I<sub>a</sub>** is the current causing the automatic disconnection of the protective device within the maximum disconnecting times required by IEC 60364-41 that are:

- 400 ms for final circuits not exceeding 32A (at 230 / 400V AC)
- 5 s for distribution circuits and circuits over 32A (at 230 / 400V AC)

The compliance with the above rules shall be verified by:

- 1) Measurement of the fault loop impedance  $Z_s$  by Loop tester.
- 2) Verification of the characteristics and/or the effectiveness of the associated protective device. This verification shall be made:

- for circuit-breakers and fuses, by visual inspection (i.e. short time or instantaneous tripping setting for circuit-breakers, current rating and type for fuses);
- for RCDs, by visual inspection and test using RCD testers recommending that the disconnecting times mentioned above are met (Please see RCD TEST section).

For instance in a TN system with nominal mains voltage  $U_o = 230$  V protected by MCBs (Miniature Current Breakers) required by BSEN 60898, the max  $Z_s$  values could be:

Protected by BSEN 60898 MCB with $U_0 = 230V$				
	MCB (Disconn. Time 0.4 and 5s)		MCB (Disconn. Time 0.4s)	MCB (Disconn. Time 5s)
	B	C	D	D
Current rating	Zs ( $\Omega$ )	Zs ( $\Omega$ )	Zs ( $\Omega$ )	Zs ( $\Omega$ )
6	7.28	3.64	1.82	3.64
10	4.37	2.19	1.09	2.19
16	2.73	1.37	0.68	1.37
20	2.19	1.09	0.55	1.09
25	1.75	0.87	0.44	0.87
32	1.37	0.68	0.34	0.68
40	1.09	0.55	0.27	0.55
50	0.87	0.44	0.22	0.44
63	0.69	0.35	0.17	0.35

Source: BS7671:2008 AMD 3:2015

The most comprehensive loop testers or Multifunction testers also have the Prospective Fault current measurement. In this case, Prospective Fault current measured values must be higher than the  $I_a$  of the protective device concerned.



Below is a practical example of verification of the protection by MCB in a TN system according to the International Standard IEC 60364.

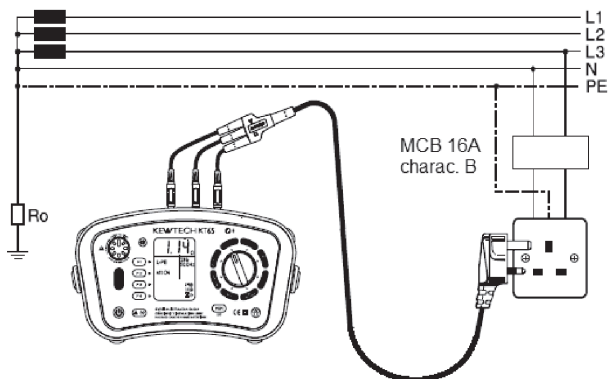

Fig. 27

## LOOP/PSC/PFC

Maximum value of  $Z_s$  (in the table above) for this example is  $2.73 \Omega$  (MCB 16A, characteristic B).

The instrument reads  $1.14 \Omega$  (or 202 A on Fault current range) and consequently the condition  $Z_s \times I_a \leq U_0$  is met.

In fact the  $Z_s$  of  $1.14 \Omega$  is less than  $2.73 \Omega$ .

In other words, in case of a fault between phase and earth, the wall socket tested in this example is protected because the MCB will trip within the disconnection time required.

### 9.2 Principles of the measurement of line impedance and PSC

The method for measuring Line – neutral impedance and line-line impedance is exactly the same as for earth fault loop impedance measurement with the exception that the measurement is carried out between line and neutral or line and line.

Prospective short circuit or fault current at any point within an electrical installation is the current that would flow in the circuit if no circuit protection operated and a complete (very low impedance) short circuit occurred. The value of this fault current is determined by the supply voltage and the impedance of the path taken by the fault current. Measurement of prospective short circuit current can be used to check that the protective devices within the system will operate within safety limits and in accordance with the safe design of the installation. The breaking current capacity of any installed protective device should be always higher than the prospective short circuit current.

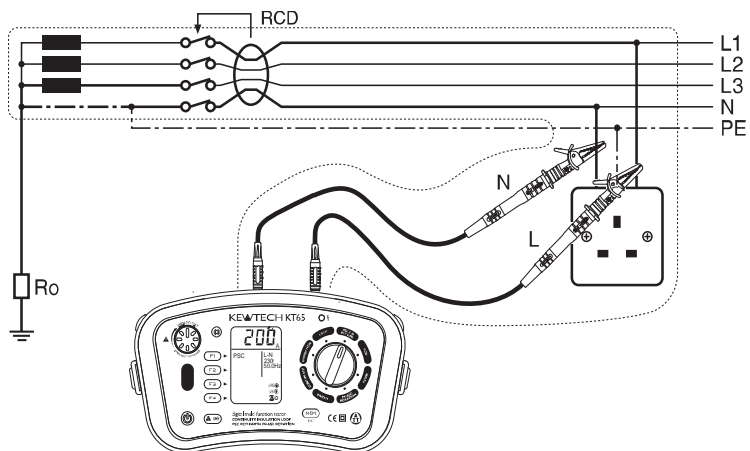

Fig. 28



### 9.3. Operating instructions for LOOP and PSC/PFC

#### 9.3.1 Initial Checks: to be carried out before any testing

##### 1. Preparation

Always inspect your test instrument and lead accessories for abnormality or damage:

If abnormal conditions exist DO NOT PROCEED WITH TESTING. Have the instrument checked by Kewtech.

#### Operation of Function Switch

##### LOOP

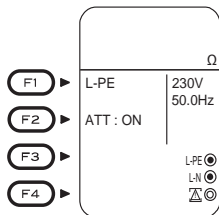

Fig. 29

F1 Switches measurement mode:  
L-PE or L-N/L-L

F2 ATT setting (on or off)

F3 Select resolution 0.01 Ω or 0.001 Ω  
(In case of L-PE)

F4 Loop limit value setting.

##### PSC/PFC

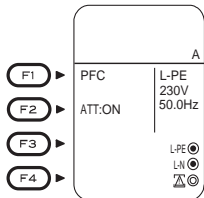

Fig. 30

F1 Switches measurement mode:  
PFC or PSC

F2 ATT setting (on or off)

F3 N/A

F4 N/A

(1) Press the Power button and turn on the instrument. Turn the Function switch and set it to either the LOOP or PSC/PFC position.

(2) Insert the Test Lead into the instrument. (Fig.31)

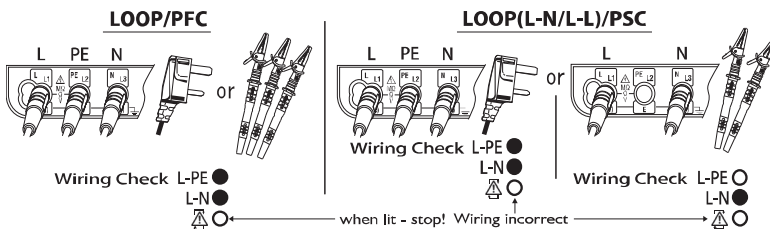

Fig. 31

## LOOP/PSC/PFC

- (3) Press the MODE switch(F1) and select L-N to measure Loop(L-N/L-L) or PSC or select L-PE to measure earth loop impedance or PFC. Display changes automatically as follows depending on the applied voltages while LOOP(L-N/L-L) or PSC is selected.

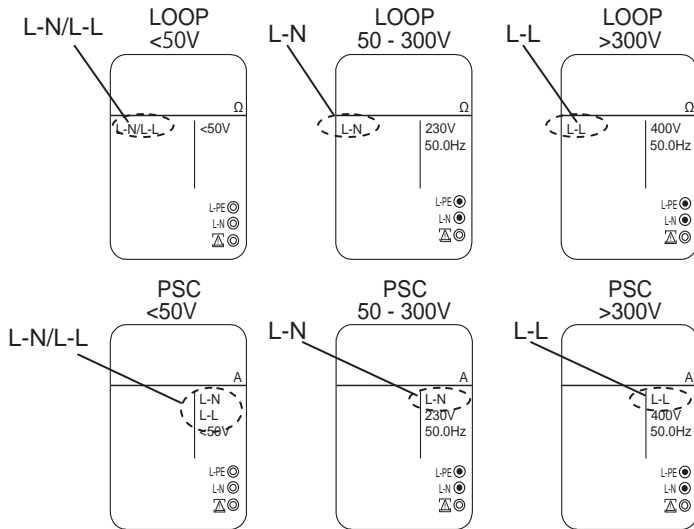

Fig. 32

- (4) Pressing the ATT switch (F2) disables ATT mode. Then “ATT OFF” is displayed on the LCD.

▲ATT(Anti Trip Technology) is to measure LOOP resistances without tripping the RCDs rated at 30mA or more. “ATT ON” is displayed while it is activated.

- (5) Press the Resolution switch (F3) to select 0.01  $\Omega$  resolution or 0.001  $\Omega$  resolution (only available with ‘ATT OFF’).

## 2. Wiring Check

After the connection, ensure that the symbols for Wiring check on the LCD are in the status indicated in Fig.31 before pressing the test button.

If the status of the symbols for Wiring check differ from Fig.31 or  symbol is indicated on the LCD, DO NOT PROCEED AS THERE IS INCORRECT WIRING. The cause of the fault must be investigated and rectified.

## 3. Voltage Measurement

When the instrument is first connected to the system, it will display the line-earth voltage (MODE L-PE) or line-neutral voltage (MODE L-N/L-L) which is updated every 1s. If this voltage is not normal or as expected, DO NOT PROCEED.

### 9.3.2 Measurement of LOOP and PSC/PFC

#### a. Measurement at Mains Socket Outlet

Connect the mains test lead to the instrument. Insert the moulded plug of mains test lead into the socket to be tested. (see Fig.33)

Press MODE Switch (F1) and select L-N or PSC to measure between Line – Neutral, or L-PE or PFC to measure between Line-PE.

#### Carry out the initial checks

Press the test button. A beep will sound as the test is conducted and the value of loop impedance will be displayed.

#### b. Measurement at the distribution board

Connect the distribution board lead ACC065 to the instrument.

#### Measurement of Line – Earth Loop Impedance and PFC

Press the Mode Switch (F1) and select L-PE or PFC.

Connect the green PE lead of the ACC065 to the earth, the blue N lead to the neutral of the distribution board and the brown L lead to one 'line' of the distribution board. (See Fig.34)

#### Measurement of Line – Neutral Loop Impedance and PSC

Press the Mode Switch (F1) and select L-N/L-L or PSC.

Connect the blue N lead of the ACC065 to the neutral of the distribution board, the brown L lead to one line of the distribution board. (See Fig.35)

#### Carry out the initial checks

Press the test button. A beep will sound as the test is conducted and the value of loop impedance will be displayed. When disconnecting from the distribution board, it is good practice to disconnect the line first.

#### c. Measurement between LINE-LINE

Connect the distribution board lead ACC065 to the instrument.

Press the Mode Switch(F1) and select L-N/L-L or PSC.

Connect the blue N lead of the ACC065 to the line of the distribution board, the brown L lead to another line of the distribution board.

(See Fig.36)

#### Carry out the initial checks

Press the test button. A beep will sound as the test is conducted and the value of loop impedance will be displayed.

- ▲ If the display shows '>' then this usually means the value measured exceeds the range.
- ▲ ATT mode enables a measurement without tripping the RCDs with the rated residual current of 30mA or more.
- ▲ Measurement in ATT mode requires longer time than that is required for the other measurements (approx. 7 sec). When measuring a circuit with a large

electrical noise present, the 'Noise' Message is displayed on the LCD and the measurement time will be extended to 20 sec. If the 'NOISE' symbol is displayed on the LCD, it is recommended to disable the ATT mode and take a measurement (RCDs may trip).

- ▲ If an impedance of 20 Ω or more is measured between L-N during measurements with ATT enabled, “**L-N>20Ω**” is displayed on the LCD and no measurement can be made. In this case, disable the ATT function and make a measurement. When a large contact voltage exists in the circuit under test, “**N-PE HiV**” is displayed on the LCD and no measurement can be made. In this case, disable the ATT function and make measurement. Be aware that if the ATT mode is disabled, RCDs may trip.
- ▲ Measured result may be influenced depending on the phase angle of the distribution system when making measurement near a transformer and the result may lower than the actual impedance value. Errors in measured result are as follows.

System Phase Difference	Error (approx.)
10°	-1.5%
20°	-6%
30°	-13%

- ▲ In case of PFC Function, ATT mode is automatically enabled after one measurement when making a measurement with ATT mode disabled.

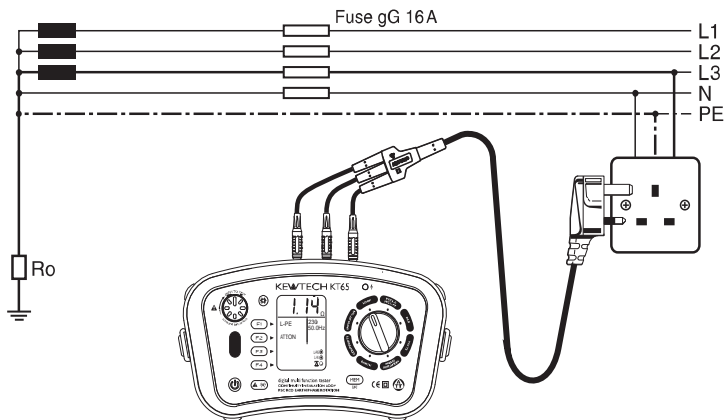

Fig. 33 Connection for using Outlet

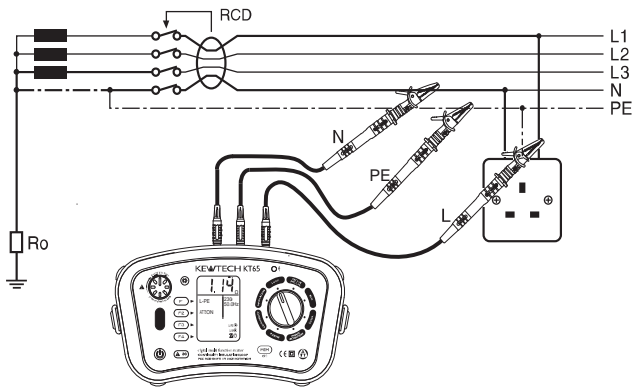

Fig.34 Connection for distribution

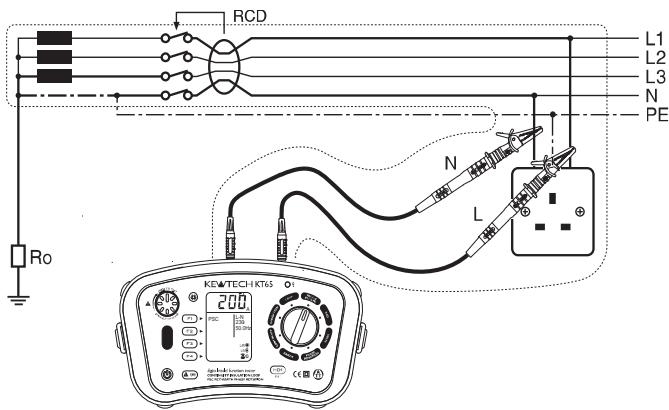

Fig.35 Connection for Line – Neutral measurement

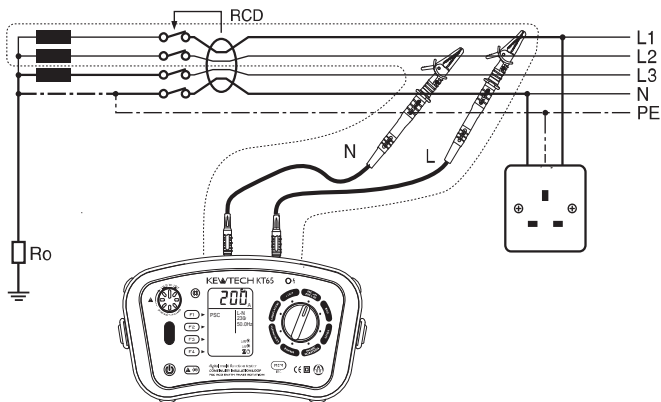

Fig.36 Connection for Line – Line measurement

**9.3.3 How to set loop limit value**

KT65DL displays limit value of loop measurement (Zs) according to the protection device in measuring circuit. The setting method is the following procedure. When L-PE measurement is selected, loop limit value is displayed.

(1) Press F4 switch in stand-by mode.(fig37-1)

LOOP LIMIT SETTING screen is displayed.(fig37-2)

(2) Press F1(Prot.) Switch to select the protection device. You can select in the following protection devices. If "OFF" is selected, Limit value is not displayed.

Protection device:

MCB B, MCB C, MCB D, MCB TYPE1, MCB TYPE2, MCB TYPE3, MCB TYPE4, FUSE 88-2, FUSE 88-3, RCD (TT), OFF

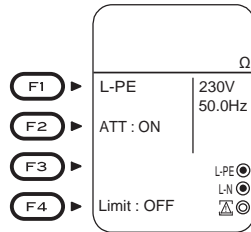

F4 ↙ Fig. 37-1

(3) Press F2 Switch to select the rated current of the protection device. If RCD is selected, select rated residual current (idn) of RCD.

You can select in the following current value. (Depending on setting of switch F1 or F3, some current value cannot be selected.)

Fuse:5,6,10,16,20,25,32,40,45,50,63, 80,100A

MCB:5,6,10,15,16,20,25,30,32,40,50, 63A

RCD:30,100,300,500,1000mA

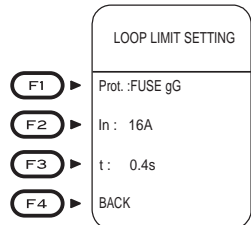

F4 ↙ Fig. 37-2

(4) Press F3 switch to select the disconnection time.

Disconnection time: 0.4s, 5s, 0.4s@80%Z, 5s@80%Z

If RCD is selected, Press F3 switch to select Uc limit value or loop limit value.

Limit Value:Uc25V, Uc50V, 100 Ω, 200 Ω

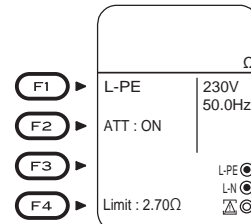

Fig. 37-3

(5) Press BACK (F4) switch to return stand-by screen.

Loop limit value is displayed. (Fig37-3)

## 10.1 Principles of RCD Measurement

The RCD tester is connected between phase and protective conductor on the load side of the RCD after disconnecting the load.

A precisely measured current for a carefully timed period is drawn from the phase and returns via the earth, thus tripping the device. The instrument measures and displays the exact time taken for the circuit to be opened.

An RCD is a switching device designed for breaking currents when the residual current attains a specific value. It works on the basis of the current difference between phase currents flowing to different loads and returning current flowing through the neutral conductor (for a single-phase installation). In the case where the current difference is higher than the RCD tripping current, the device will trip and disconnect the supply from the load.

There are two parameters for RCDs; the first due to the shape of the residual current wave form (types AC and A) and the second due to the tripping time (types G and S).

▲  RCD type AC will trip when presented with residual sinusoidal alternating currents whether applied suddenly or slowly rising. This type is the most frequently used on electrical installations.

▲  RCD type A will trip when presented with residual sinusoidal alternating currents (similar to type AC) and residual pulsating direct currents (DC) whether suddenly applied or slowly rising. This type of RCD is not commonly used at present, however, it is increasing in popularity and is required by the local regulations in some countries.

Making measurement with  setting uses pulsating direct currents for test.

▲ RCD type G. In this case G stands for general type (without tripping time delay) and is for general use and applications.

▲  RCD type S where S stands for selective type (with tripping time delay). This type of RCD is specifically designed for installations where the time delay characteristic is required.

Given that when the protective device is an RCD,  $I_{\Delta n}$  is typically 5 times the rated residual operating current  $I_{\Delta n}$ , then the RCD must be tested recommending the tripping time, measured by RCD testers or Multifunction testers, shall be lower than the maximum disconnecting times required in IEC 60364-41 (see also LOOP/PSC/PFC section) that are:

TT system (at 230V / 400V AC)	200 ms for final circuits not exceeding 32A 1000 ms for distribution circuits and circuits over 32A
TN system (at 230V / 400V AC)	400 ms for final circuits not exceeding 32A 5 s for distribution circuits and circuits over 32A

## RCD

However it is also good practice to consider even more stringent trip time limits, by following the standard values of trip times at  $I\Delta n$  defined by IEC 61009 (EN 61009) and IEC 61008 (EN 61008). These trip time limits are listed in the table below for  $I\Delta n$  and  $5I\Delta n$ :

Type of RCD	$I\Delta n$	$5I\Delta n$
General(G)	300ms max allowed value	40ms max allowed value
	500ms max allowed value	150ms max allowed value
Selective(S)	130ms min allowed value	50ms min allowed value

Examples of instrument connection

Practical example of 3-phase + neutral RCD test in a TT system.

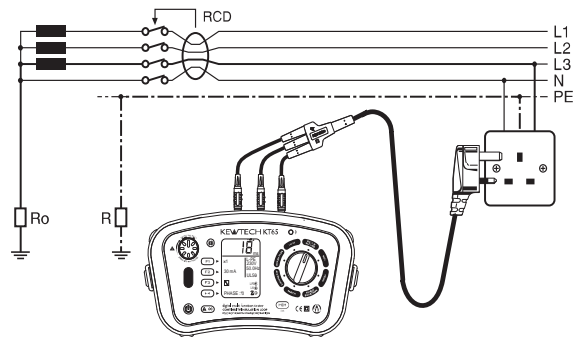

Fig.38

Practical example of single phase RCD test in a TN system.

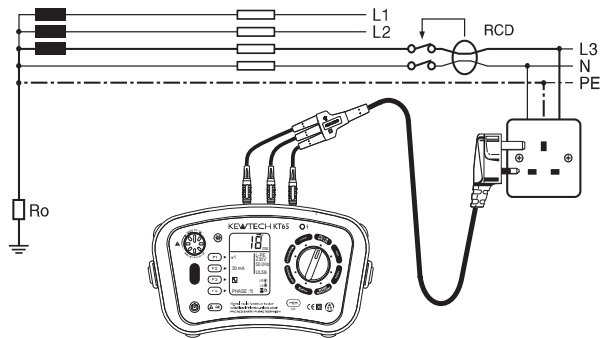

Fig.39



Practical example of RCD test with distribution leads.

RCD

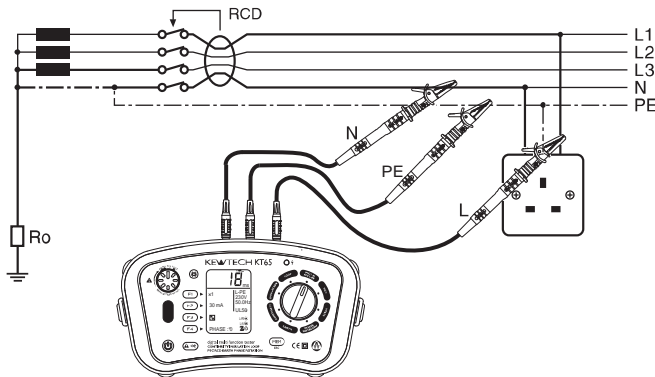

Fig. 40

## 10.2 Operating Instructions for RCD

### 10.2.1 Initial Checks: to be carried out before any testing;

#### 1. Preparation

Always inspect your test instrument and lead accessories for abnormality or damage:

If abnormal conditions exist DO NOT PROCEED WITH TESTING. Have the instrument checked by Kewtech.

#### Operation of Function Switch

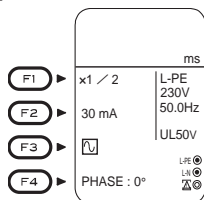

F1 Measurement mode setting  
(X1/2, X1, X5, Ramp, Auto)

F2  $I \Delta n$  setting

F3 RCD Type setting (  $\Delta$ ,  $\Delta$ ,  $\Delta$ ,  $\Delta$ ,  $\Delta$ ,  $\Delta$  )

F4 PHASE setting ( $0^\circ$ ,  $180^\circ$ )

Fig. 41

1. Press the Power button and turn on the instrument.  
Turn the rotary switch and select the RCD function.
2. Press the MODE switch(F1) and select any desirable measurement mode.

X1/2	For testing RCD's to verify that they are not too sensitive.
------	--------------------------------------------------------------

X1	For measuring the trip time.
----	------------------------------

X5	For testing at $I \Delta n \times 5$
----	--------------------------------------

RAMP	For measuring the tripping level in mA.
------	-----------------------------------------

AUTO	For automatic measurement in following sequence: X1/2( $0^\circ$ ), X1/2( $180^\circ$ ), X1( $0^\circ$ ), X1 ( $180^\circ$ ), X5( $0^\circ$ ), X5( $180^\circ$ )
------	---------------------------------------------------------------------------------------------------------------------------------------------------------------------

- RCD**
3. Press the I $\Delta$ n switch (F2) to set Rated Tripping Current (I $\Delta$ n) to the rated trip current of the RCD.
  4. Press (F3) to select the RCD type.  
Refer to "10.1 Principles of RCD measurement" for the details of RCD type.
  5. Press (F4) to select phase at which the test current should start.

**\*UL value change**

As a UL value, 25V or 50V is selectable. Refer to "6. Configuration" in this manual and select either of them.

**2. Wiring Check**

1. Insert the Test Lead into the instrument. (Fig.42)

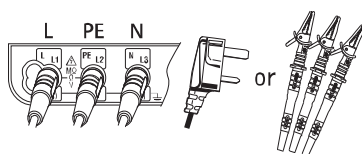

Wiring Check L-PE ●  
 L-N ●  
 ⚠○ ← when lit - stop! Wiring incorrect

Fig. 42

2. Connect the test leads to the circuit to be tested. (Fig.38, 39, 40)
3. After the connection, ensure that the symbols for Wiring check on the LCD are in the status indicated in Fig.42 before pressing the test button.

If the status of the symbols for Wiring check differ from Fig.42 or ⚠○ symbol is indicated on the LCD, DO NOT PROCEED AS THERE IS INCORRECT WIRING. The cause of the fault must be investigated and rectified.

**3. Voltage Measurement**

When the instrument is first connected to the system, it will display the line-earth voltage which is updated every 1s. If this voltage is not normal or as expected, DO NOT PROCEED.

NOTE: This is a single phase (230V AC) instrument and under **no circumstances** should it be connected to 2- phases or a voltage exceeding 230VAC+10%.

If the input voltage is greater than 260V the display will indicate '>260V' and RCD measurements can not be made even if the Test button is pressed.

## 10.2.2 RCD Measurement

### a) Single Tests

1. Press the Test button

Operating time of RCD is displayed on LCD. At Ramp test, operating current value of RCD will be displayed.

- ▲  $\times 1/2$ .....The Breaker should not trip.
  - ▲  $\times 1$ .....The Breaker should trip.
  - ▲  $\times 5$ .....The Breaker should trip.
  - ▲ Auto Ramp(▲).....The Breaker should trip. The tripping current should be displayed.
2. Press the  $0^\circ / 180^\circ$  switch to change the phase and repeat step (1).
  3. Change the phase again and repeat step (1).

### b) Auto Test

Measurements are automatically performed under the Auto Test function in the following

sequence:  $X1/2(0^\circ)$ ,  $X1/2(180^\circ)$ ,  $X1(0^\circ)$ ,  $X1(180^\circ)$ ,  $X5(0^\circ)$ ,  $X5(180^\circ)$ .

1. Press F1 to select Auto
2. Press F2 & F3 to select  $I\Delta n$  & RCD type
3. Press the Test button. The KT65DL will automatically conduct the sequence as above. When the RCD trips each time reset it.
4. Return to the tester and the results will be displayed

- ▲ Be sure to return the tested RCD to the original condition after the test.
- ▲ When the  $U_c$  voltage rises to UL value or greater, the measurement is automatically suspended and " $U_c > UL$ " is displayed on the LCD.
- ▲ If " $I\Delta n$ " setting is greater than the rated residual current of the RCD, the RCD will trip and "no" may be displayed on LCD.
- ▲ If a voltage exists between the protective conductor and earth, it may influence the measurements.
- ▲ If a voltage exists between neutral and earth, it may influence the measurements, therefore, the connection between neutral point of the distribution system and earth should be checked before testing.
- ▲ If leakage currents flow in the circuit following the RCD, it may influence the measurements.
- ▲ The potential fields of other earthing installations may influence the measurement.

- RCD**
- ▲ Special conditions of RCDs of a particular design, for example S- type, should be taken into consideration.
  - ▲ The earth electrode resistance of a measuring circuit with a probe shall not exceed table1.
  - ▲ Equipment following the RCD, e.g. capacitors or rotating machinery, may cause a significant lengthening of the measured trip time.

### 11.1 Principles of Earth Measurement

This Earth function is to test power distribution lines, in-house wiring system, electrical appliances etc.

This instrument makes earth resistance measurement with fall-of-potential method, which is a method to obtain earth resistance value  $R_x$  by applying AC constant current  $I$  between the measurement object  $E$  (earth electrode) and  $H(C)$  (current electrode), and finding out the potential difference  $V$  between  $E$  and  $S(P)$  (potential electrode).

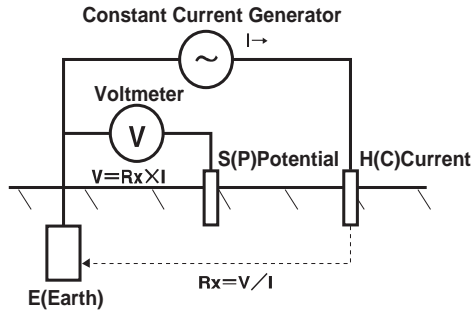

Fig. 43

### 11.2 Earth resistance Measurement

#### WARNING

The instrument will produce a maximum voltage of about 50V between terminals E-H(C) in earth resistance function. Take enough caution to avoid electric shock hazard.

#### CAUTION

When measuring earth resistance, do not apply voltage between measuring terminals.

1. Select Earth function with the Rotary Switch
2. Insert the Test Leads (Model7228: Optional Accessory) into the instrument. (Fig.44)

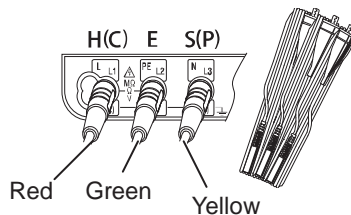

Fig. 44

3. Test Lead connection

Stick the auxiliary earth spikes  $S(P)$  and  $H(C)$  into the ground deeply. They should be aligned at an interval of 5-10m from the earthed equipment under test. Connect the green wire to the earthed equipment under test, the yellow wire to the auxiliary earth spike  $S(P)$  and the red wire to the auxiliary earth spike  $H(C)$  from terminals  $E$ ,  $S(P)$  and  $H(C)$  of the instrument in order.

## Earth

Note :

- ▲ Make sure to stick the auxiliary earth spikes in the moist part of the soil. Give enough water where the spikes have to be stuck into the dry, stony or sandy part of the earth so that it may become moist.
- ▲ In case of concrete, lay the auxiliary earth spike down and water it, or put a wet dustcloth etc. on the spike when making measurement.

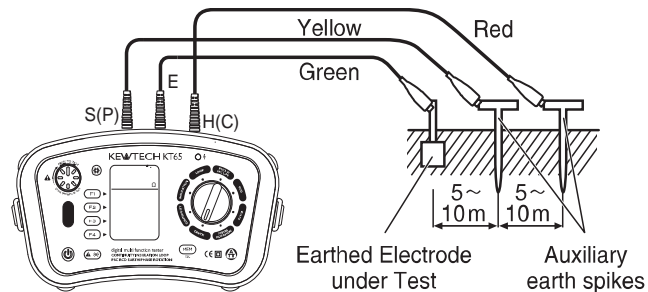

Fig. 45

4. Press the test button, the display will show the earth resistance of the circuit.
  - ▲ If measurement is made with the probes twisted or in touch with each other, the reading of the instrument may be affected by induction. When connecting the probes, make sure that they are separated.
  - ▲ If earth resistance of auxiliary earth spikes is too large, it may result in inaccurate measurement. Make sure to stick the auxiliary earth spike and H(C) into the moist part of the earth carefully, and ensure sufficient connections between the respective connections. High auxiliary earth resistance may exist if “ $R_S$  Hi” or “ $R_H$  Hi” is displayed during measurements.
  - ▲ Large errors may occur in the measured earth resistance when earth voltage of 10V or more exist. In this case, power off the devices which is using earth resistance under test to reduce the earth voltages.

1. Press the Power button and turn on the instrument. Turn the rotary switch and select the PHASE ROTATION function.
2. Insert the Test Leads into the instrument. (Fig.46)

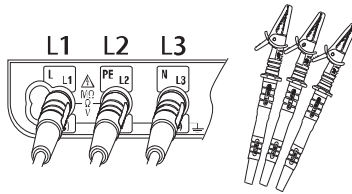

Fig. 46

3. Connect each test leads to a circuit. (Fig.47)

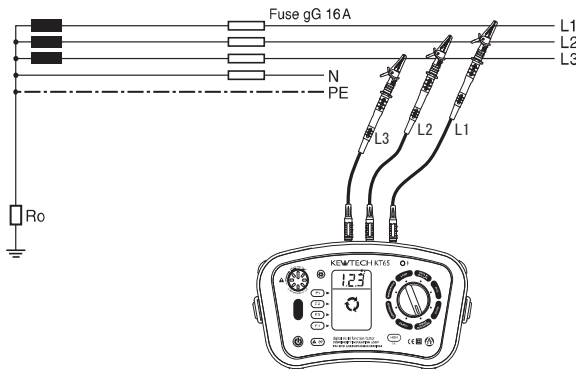

Fig. 47

4. Results are displayed as follows.



Correct phase sequence

Fig. 48



Reversed phase sequence

Fig. 49

- ▲ When a message “No 3-phase system” or “- - -” is displayed, the circuit may not be a 3-phase system or a wrong connection may have been made. Check the circuit and the connection.
- ▲ Presence of Harmonics in measurement voltages, such as an inverter power supply, may influence the measured results.

### 13 Volts

1. Press the Power button and turn on the instrument. Turn the rotary switch and select the VOLTS function.
2. Insert the Test Leads into the instrument. (Fig.50)

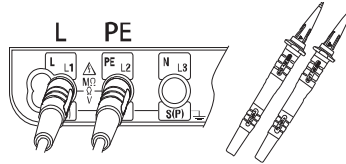

Fig. 50

3. Voltage value and frequency will be displayed on the LCD when applying AC voltage.

Note : A message “DC V” may be displayed when measuring AC voltages with frequencies out of the range 45Hz - 65Hz.

### 14 Touch Pad

1. The touch pad measures the potential between the operator and the tester's PE terminal. A message “PE HiV” is displayed on the LCD with the audible buzzer if a potential difference of 100V or more is present between the operator and the PE terminal at touching the Touch pad.
2. Touch Pad function can be enabled and disabled (ON / OFF); refer to ” 6. Configuration” in this manual and select ON or OFF. In case that OFF is selected, a warning for “PE HiV” does not appear and the buzzer does not sound.

\* Initial value: ON

Note : A message “PE HI V” may be displayed when testing inverters or measuring voltages containing high frequencies even if a user isn't touching with the Touch Pad.

### 15 Back Light

Pressing the Back Light Button selects Backlight ON / OFF. Backlight automatically turns off in 60 sec after it turns on. Backlight at powering on the instrument can be set either ON or OFF. Refer to “6. Configuration” in this manual how to select ON / OFF.



Measured result at each function can be saved in the memory of the instrument. (MAX : 1000)

**16.1 How to save the data**

Save the result according to following sequence.

(1) Measured result.

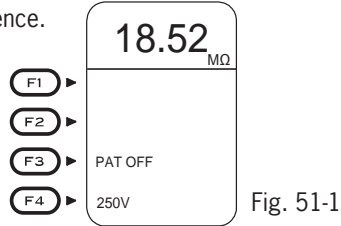

Fig. 51-1

(2) Press **MEM** to enter into SAVE MODE.

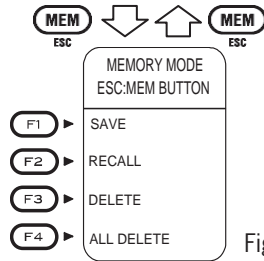

Fig. 51-2

(3) Press **F1** to enter into SAVE MODE.

▲ In case of PAT mode (Insulation or Continuity function)	▲ Other
1.ID No 2.SITE No 3.DATA No	1. TYPE (Selection items are shown in the table below) 2. CIRCUIT No 3. BOARD No 4. SITE No 5. DATA No

Press the SELECT Button to choose the parameter to change.

▲In case of PAT mode : ID No → SITE No →MENU→DATA No

When saving an insulation test the ID No, automatically advances by 1.

▲Other : TYPE → CIRCUIT No → BOARD No → SITE No →MENU→ DATA No

If you select “MENU” and press F4(OK) switch, “Recall / delete screen” will be displayed.(Fig 52-2). You can recall or delete the saved data at “Recall / delete screen” . Use the UP or DOWN Button and change settings.

TYPE Selection	
Continuity	r1, r2, rn, R1+R2, R2
Insulation	L/L, L/N, L/E,N/E
Loop(L-PE)	Zs, Z <sub>E</sub>
RCD	1st RCCB, 2nd RCCB, 3rd RCCB, RCBO

Keep the UP/DOWN Key pressed down to alter the number quickly.

**Memory Function**

(4) Press OK (**F4**). (Confirmed)

(5) "SAVING" is displayed for about 2 sec on the LCD, and then returns to the start screen. Saving completes.

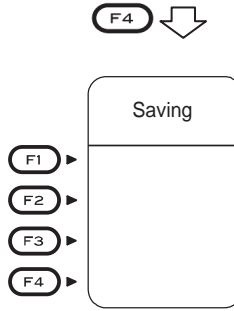

Fig. 51-3

Returns to Normal mode once data save completes. (Measurement mode)

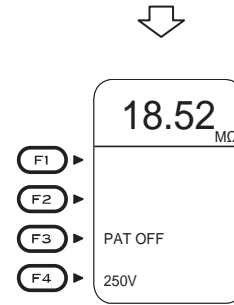

Fig. 51-4

Normal mode

## 16.2 Recall the saved data

Save data can be displayed on LCD according to following sequence.

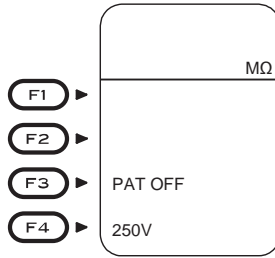

Fig. 52-1

- (1) Press **MEM** ESC to enter into Recall/delete screen.

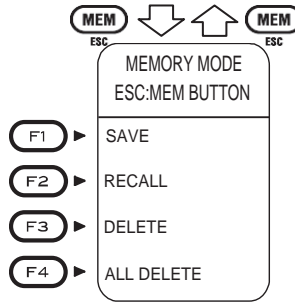

Fig. 52-2

- (2) Press **F2** to enter into RECALL MODE.



- (3) Press Up (**F1**) or DOWN (**F2**) and select Data No.

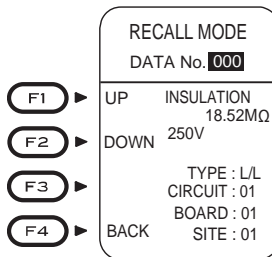

Fig. 52-3

Keep the UP/DOWN Key pressed down until a buzzer sounds to skip the number containing no data and display the next data.

**Memory Function**

**16.3 Delete the saved data**

Save data can be deleted according to following sequence.

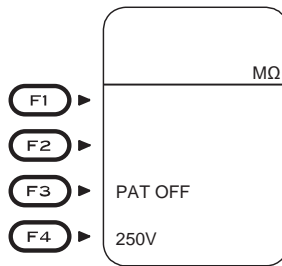

Fig. 53-1

- (1) Press **MEM** <sub>ESC</sub> to enter into Recall/delete screen.

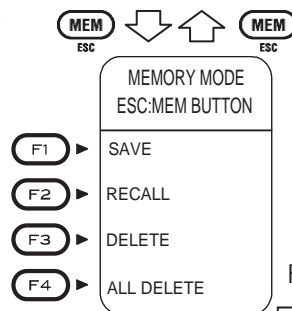
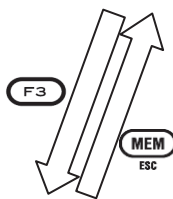

Fig. 53-2

**DELETE**

**DELETE ALL**

- (2) Press **F3** to enter into DELETE MODE



- (2) Press **F4** to enter into ALL DELETE MODE

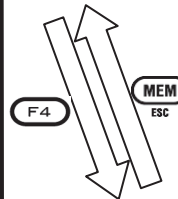

- (3) Press Up (**F1**) or DOWN (**F2**) and select Data No.

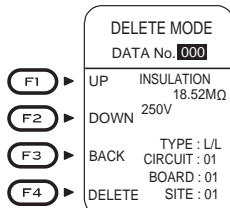

Fig. 53-3

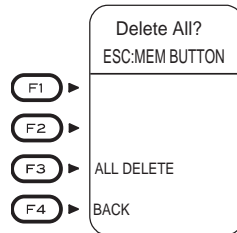

Fig. 53-4

- (4) Press DELETE (**F4**). (Confirmed)



- (3) Press ALL DELETE (**F3**). (Confirmed)

**DELETE**

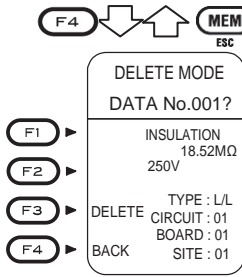

Fig. 53-5

(5) Press  
DELETE  
(F3).  
(Confirmed)

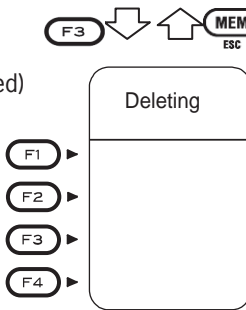

Fig. 53-7

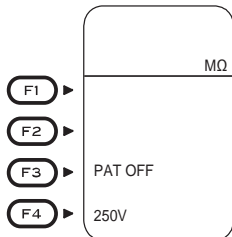

Fig. 53-9

(6) Returns to Normal mode when  
selected data deleted.  
(Measurement mode)

**ALL DELETE**

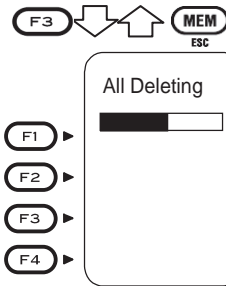

Fig. 53-6

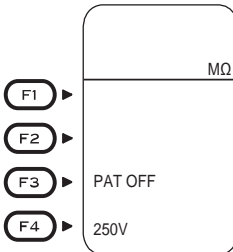

Fig. 53-8

(4) Returns to Normal mode when  
selected data is deleted.  
(Measurement mode)

**Memory  
Function**

**16.4 Transfer the stored data to PC**

The stored data can be transferred to PC via Optical Adapter Model8212USB (Optional Accessory).

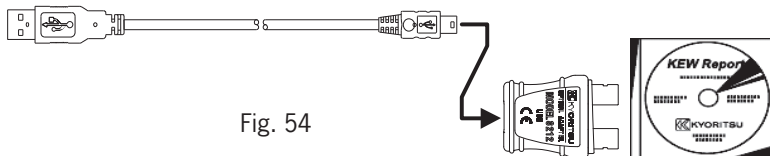

Fig. 54

● How to transfer the data:

(1) Connect Model8212USB to the USB Port of a PC.(Special driver for Model8212USB should be installed. See the instruction manual for Model8212USB for further details.)

(2) Insert Model8212USB into the KT65DL as shown in Fig 55.  
Test Leads should be removed from the KT65DL at this time.

(3) Power on the KT65DL . (Any function is OK.)

(4) Start special software "KEW Report" on your PC and set the communication port.

Then click "Down load" command, and the data in the KT65DL will be transferred to your PC.

Please refer to the instruction manual of Model 8212USB and HELP of KEW Report for further details.

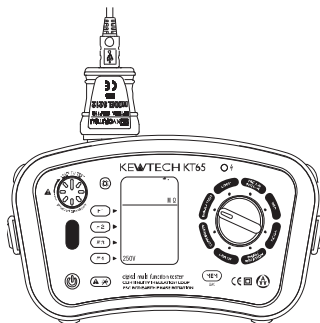



Fig. 55

Note: Use "KEW Report" with version 2.20 or more.

- 17.1 If the symbol  appears, this means that the test resistor is too hot and the automatic cut out circuits have operated. Allow the instrument to cool down before proceeding. The overheat circuits protect the test resistor against heat damage.
- 17.2 The test button may be turned clockwise to lock it down. In this auto mode, when using distribution board lead ACC065, tests are conducted by simply disconnecting and reconnecting the red phase prod of the ACC065 avoiding the need to physically press the test button i.e. 'hands free'.
- 17.3 When the display shows the low battery indication, () , disconnect the test leads from the instrument. Remove the battery cover and the batteries.
- 17.4 If at any time during testing there is a momentary degradation of reading, this may be due to excessive transients or discharges on the system or local area. Should this be observed, the test should be repeated to obtain a correct reading. If in doubt, always contact Kewtech.

## 18 Battery replacement

When the display shows the low battery indication, **B**, disconnect the test leads from the instrument. Remove the battery cover and the batteries. Replace with eight (8) new 1.5V AA batteries, taking care to observe correct polarity. Replace the battery cover.

## 19 Fuse replacement

The continuity test circuit is protected by a 600V 0.5A HRC ceramic type fuse situated in the battery compartment, together with a spare. If the instrument fails to operate in the continuity test mode, first disconnect the test leads from the instrument. Next remove the battery cover, take out the fuse and test its continuity with another continuity tester. If it has failed, replace it with a spare, before refitting the battery cover. Do not forget to obtain a new fuse and place it in the spare position. If the instrument will not operate in the loop impedance, PSC/PFC and RCD modes, it may be that the protective fuses fitted on the printed circuit board have blown. If you suspect that the fuses have failed, return the instrument to Kewtech for service - do not attempt to replace the fuses yourself.

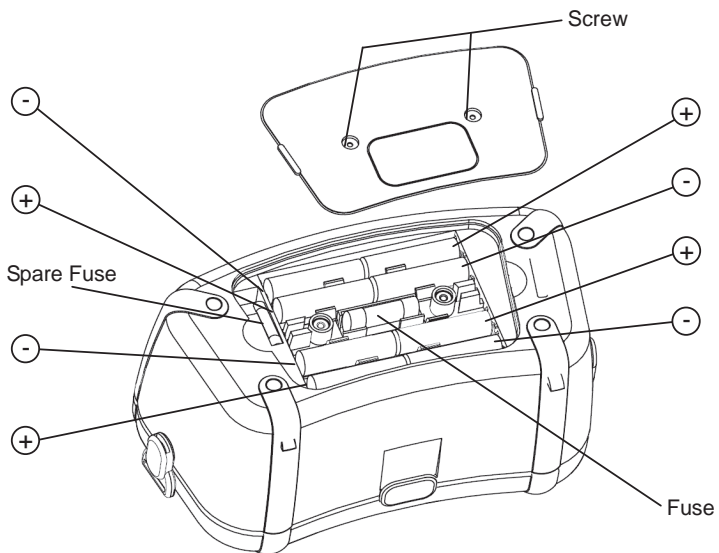

Fig. 56



If this tester should fail to operate correctly, return it to Kewtech marked for the attention of the Service Department, stating the exact nature of the fault. Make sure that:

- a. operating instructions have been followed
- b. leads have been inspected
- c. the unit is returned with all accessories

Regular re-calibration is recommended for this instrument. We recommend that with normal use, the instrument is calibrated at least once in every 12 month interval. When this is due for re-calibration return it to Kewtech marked for the attention of the Calibration Department and be sure to include all accessory leads, as they are part of the calibration procedure. The mains lead supplied with this instrument (KAMP12) for testing at sockets is part of the instrument. It directly affects the accuracy of the loop and PSC/PFC readings. As such always keep it with the instrument and remember to return it with the instrument when servicing and calibration is required. If other leads are used then readings may not be correct unless they are calibrated with the instrument. If this product needs cleaning use a lightly damp cloth to wipe its surfaces.

DO NOT use strong cleaning agents as these may damage the plastic surfaces. Kewtech reserve the right to change specifications and design without notice and without obligation.

## 21 Pat test with the Pat adapter 1

Using the Kewtech Pat adapter with the KT65DL to undertake portable appliance testing

Before each use the adapter should be inspected to ensure that it is not damaged in any way. If any damage is noticed the adapter should be withdrawn from service and replaced.

### 1. Earth Bond.

- a. This is a continuity test. Connect the test leads to the instrument as shown in figure 12 on page 17
- b. Connect one test lead from the KT65DL into the Pat Adapter 1 at the terminal marked **⊖** (Earth Testing)
- c. Plug the appliance to be tested into the three pin socket on the front of the Pat Adapter
- d. Connect the other test lead from KT65DL to the earthed position on your appliance to be tested.
- e. Conduct a test.

Note: The test lead resistance can be auto-nulled from the test result, see section 7.1 for guidance

### 2. Insulation Class I

- a. Connect the test leads to the instrument as shown in figure 20 on page 23
- b. Connect one test probe from the KT65DL to the terminal marked **L—N** (Insulation Testing) on the Pat Adapter 1 and the other test lead to the terminal marked **⊖** (Earth Testing)
- c. Plug the appliance to be tested into the three pin socket on the front of the Pat Adapter
- d. Conduct a test.

### 3. Insulation Class II

- a. Connect the test leads to the instrument as shown in figure 20 on page 23
- b. Connect one test probe from the KT65DL to the terminal marked **L—N** (Insulation Testing) on the Pat Adapter 1
- c. Plug the appliance to be tested into the three pin socket on the front of the Pat Adapter
- d. Connect the other lead from the KT65DL to the parts of your appliance to be tested.
- e. Conduct a test

In Pat CL I or Pat CL II mode the insulation 1000V range is disabled. Use 250V for:

- 1) Appliances and extension leads which include surge protection.
- 2) Where sensitive electronic equipment could be damaged.

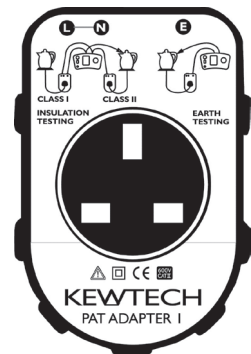

Fig. 57

## 22.1 Maximum earth fault loop impedance (Zs) for fuses with Uo of 230V

All tables have had the Cmin factor applied according to the BS7671:2008 Amendment 3 (2015)

## 22 Zs tables

Protection type	BS88-2 Fuse ref BS7671:2008 (2015)				BS88-3 Fuse ref BS7671:2008 (2015)			
	0.4s Zs (Ω)	5s Zs (Ω)	0.4s@80%Z Zs (Ω)	5s@80%Z Zs (Ω)	0.4s Zs (Ω)	5s Zs (Ω)	0.4s@80%Z Zs (Ω)	5s@80%Z Zs (Ω)
5	--	--	--	--	9.93	14.60	7.94	11.68
6	7.80	12.00	6.24	9.60	-	-	-	-
10	4.65	6.80	3.72	5.44	-	-	-	-
16	2.43	4.00	1.95	3.20	2.30	3.90	1.84	3.12
20	1.68	2.80	1.35	2.24	1.93	3.20	1.54	2.56
25	1.29	2.20	1.03	1.76	-	-	-	-
32	0.99	1.70	0.79	1.36	0.91	1.60	0.73	1.28
40	--	1.30	--	1.04	-	-	-	-
45						1.00		0.80
50	--	0.99	--	0.79	-	-	-	-
60								
63	--	0.78	--	0.62		0.68		0.55
80	--	0.55	--	0.44		0.51		0.41
100	--	0.42	--	0.34		0.38		0.30

Protection type	BS3036 ref BS7671:2008 (2015)				BS1362 ref BS7671:2008 (2015)			
	0.4s Zs (Ω)	5s Zs (Ω)	0.4s@80%Z Zs (Ω)	5s@80%Z Zs (Ω)	0.4s Zs (Ω)	5s Zs (Ω)	0.4s@80%Z Zs (Ω)	5s@80%Z Zs (Ω)
3					15.60	22.00	12.48	17.60
5	9.10	16.80	7.28	13.44				
13					2.30	3.64	1.84	2.91
15	2.43	5.08	1.94	4.07				
20	1.68	3.64	1.35	2.91				
30	1.04	2.51	0.83	2.01				
45		1.51		1.21				
60		1.07		0.86				
100		0.51		0.41				

Protection type	BS1361 ref 7671:2001			
	0.4s Zs (Ω)	5s Zs (Ω)	0.4s@80%Z Zs (Ω)	5s@80%Z Zs (Ω)
5	10.36	16.25	8.28	13.00
15	3.26	4.96	2.61	3.97
20	1.69	2.78	1.35	2.23
30	1.14	1.82	0.91	1.46
45	0.57	0.95	0.46	0.76
60		0.69		0.55
80		0.49		0.40
100		0.36		0.29

## 22.2 Maximum earth fault loop impedance (Zs) for RCBOs and MCBs with Uo of 230V

	Zs BSEN 60898 MCB & BSEN61009-1 RCBO Table							
	MCB (Disconn. time 0.4 and 5s)		MCB (Disc 0.4s)	MCB (Disc 5s)	MCB (Disconn. time 0.4 and 5s) @0.8 Z		MCB (Disc 0.4s) @80%	MCB (Disc 5s) @80%
	B	C	D	D	B	C	D	D
Current rating	Zs (Ω)	Zs (Ω)	Zs (Ω)	Zs (Ω)	Zs (Ω)	Zs (Ω)	Zs (Ω)	Zs (Ω)
6	7.28	3.64	1.82	3.64	5.82	2.91	1.46	2.91
10	4.37	2.19	1.09	2.19	3.50	1.75	0.87	1.75
16	2.73	1.37	0.68	1.37	2.18	1.09	0.55	1.10
20	2.19	1.09	0.55	1.09	1.75	0.87	0.44	0.87
25	1.75	0.87	0.44	0.87	1.40	0.70	0.35	0.70
32	1.37	0.68	0.34	0.68	1.09	0.55	0.27	0.54
40	1.09	0.55	0.27	0.55	0.87	0.44	0.22	0.44
50	0.87	0.44	0.22	0.44	0.70	0.35	0.17	0.35
63	0.69	0.35	0.17	0.35	0.55	0.28	0.14	0.28

	Zs BS3871 MCB table							
	MCB (Disconn. time 0.4 and 5s)				MCB (Disconn. time 0.4 and 5s)@0.8 Z			
	1	2	3	4	1	2	3	4
Current rating	Zs (Ω)	Zs (Ω)	Zs (Ω)	Zs (Ω)	Zs (Ω)	Zs (Ω)	Zs (Ω)	Zs (Ω)
5	10.93	6.41	4.37	0.87	8.74	5.13	3.50	0.70
6	9.10	5.21	3.64	0.73	7.28	4.16	2.91	0.59
10	5.46	3.10	2.19	0.44	4.37	2.48	1.75	0.35
15	3.64	2.08	1.45	0.29	2.91	1.66	1.16	0.24
16	3.41	1.95	1.37	0.28	2.73	1.56	1.09	0.22
20	2.73	1.56	1.09	0.22	2.18	1.25	0.87	0.17
25	2.19	1.24	0.87	0.17	1.75	1.00	0.70	0.14
30	1.82	1.05	0.73		1.46	0.84	0.59	
32	1.71	0.98	0.68		1.37	0.78	0.55	
40	1.36	0.78	0.55		1.09	0.62	0.44	
50	1.09	0.63	0.44		0.87	0.50	0.35	
63	0.86	0.49	0.35		0.69	0.40	0.28	

Correct assembly is shown in Fig 58, 59 and 60. By hanging the instrument round the neck, both hands will be left free for testing.

1. Attach the Buckle to the KT65DL as shown in Fig.58.

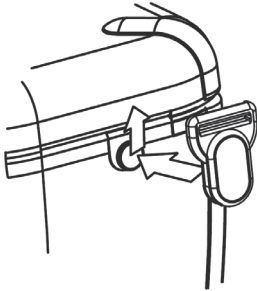

Fig. 58

Match the hole of the Buckle and the protrusion at the side face of KT65, and slide it upwards.

2. How to install the Strap belt

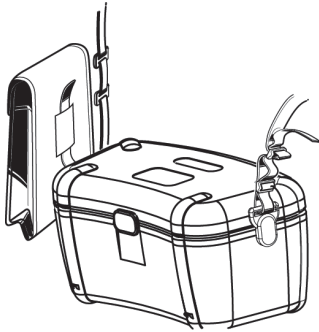

Fig. 59

Pass the strap belt down through the buckle from the top, and up through the slots of the probe case from the bottom.

3. How to fasten the Strap belt

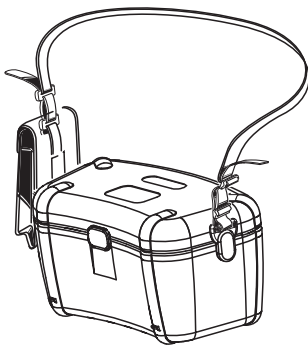

Fig. 60

Pass the strap through the buckle, adjust the strap for length and secure.

Kewtech Corporation Ltd.  
Midas House, Unit 2b  
Stones Courtyard  
High Street, Chesham  
Buckinghamshire HP5 1DE  
[www.kewtechcorp.com](http://www.kewtechcorp.com)