

INSTRUCTION MANUAL

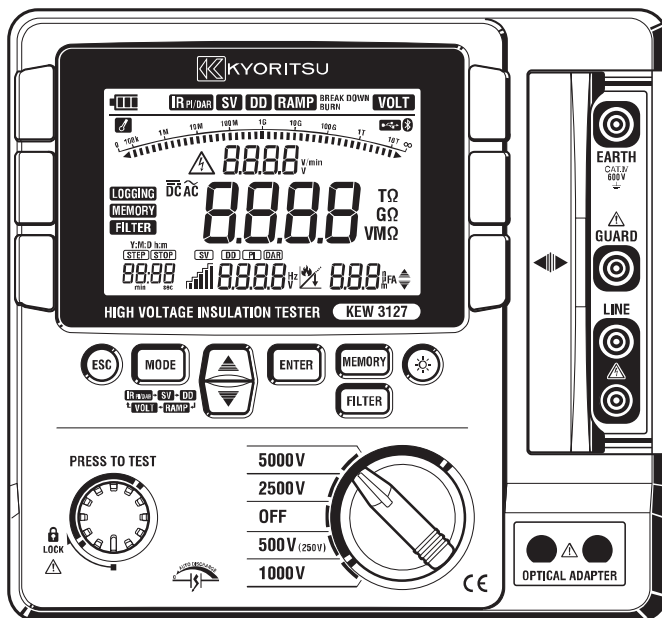

HIGH VOLTAGE INSULATION TESTER

KEW 3127



**KYORITSU ELECTRICAL
INSTRUMENTS WORKS, LTD.**

Contents

1. Safety warnings	1
2. Feature	5
3. Specification	6
4. Instrument layout	10
4-1 Instrument layout	10
4-2 LCD display	11
4-3 Opening and closing Hard case	12
4-4 Taking out KEW3127 from the Hard case	12
5. Preparation for measurement	13
5-1 Checking the battery voltage	13
5-2 Connecting test leads	13
6. Measurement	14
6-1 Mains disconnection check (Voltage measurement)	14
6-2 Insulation resistance measurement	15
6-3 About BREAKDOWN mode and BURN mode	19
6-4 Continuous measurement	20
6-5 IR _{P/DAR} Measurement	21
6-6 SV Measurement (Step Voltage)	27
6-7 DD Measurement (Dielectric Discharge)	28
6-8 Ramp Measurement	30
6-9 Voltage characteristics of measuring terminal	32
6-10 Use of Guard terminal	32
6-11 Filter function	33
6-12 Backlight function	33
6-13 Auto-power-off function	33
7. Memory function	34
7-1 Function details	34
7-2 How to save data	35
7-3 How to recall saved data	36
7-4 How to delete data	37

8. Clock Setting	38
9. Communication Function/ Software	39
9-1 KEW3127 Settings	39
9-2 How to install the Software	42
9-3 How to start “KEW Windows for KEW3127”	45
9-4 Features of KEW Smart	47
10. Battery Charging and Replacement	48
10-1 How to charge battery	48
10-2 How to replace battery	49
11. Accessories	51
11-1 Metal part for Line Probe, and replacement	51
11-2 How to use the adaptor for recorder	52
11-3 Line probe with alligator clip	52
12. Disposing the Product	53

1. Safety warnings



This instrument has been designed, manufactured and tested according to IEC 61010: Safety requirements for Electronic measuring apparatus, and delivered in the best condition after passed the inspection. This instruction manual contains warnings and safety rules which must be observed by the user to ensure safe operation of the instrument and retain it in safe condition.

Therefore, read through these operating instructions before using the instrument.

WARNING

- Read through and understand instructions contained in this manual before starting to use the instrument.
- Save and keep the manual at hand to enable quick reference whenever necessary.
- The instrument is to be used only in its intended applications.
- Understand and follow all safety instructions contained in the manual.

It is essential that the above instructions are adhered to. Failure to follow the above instructions may cause injury, instrument damage and/or damage to equipment under test.

The symbol  indicated on the instrument means that the user must refer to related parts in the manual for safe operation of the instrument. It is essential to read the instructions wherever the  symbol appears in the manual.

 **DANGER** is reserved for conditions and actions that are likely to cause serious or fatal injury.

 **WARNING** is reserved for conditions and actions that can cause serious or fatal injury.

 **CAUTION** is reserved for conditions and actions that can cause injury or instrument damage.

⚠ DANGER

- Never make measurement on the circuit in which electrical potential to ground over 600V exists.
- Do not attempt to make measurement in the presence of flammable gasses. Otherwise, the use of the instrument may cause sparking, which can lead to an explosion.
- Never attempt to use the instrument if its surface or your hand is wet.
- Be careful not to short-circuit the power line with the metal part of the test leads when measuring voltage. It may cause personal injury.
- Do not apply inputs exceeding the maximum allowable measuring range.
- Do not press the Test button with test leads connected to the instrument.
- Never open the battery compartment cover while making a measurement.
- Do not touch the circuit under test while measuring insulation resistance or right after a measurement. You may get an electric shock by a test voltage.







⚠ WARNING

- Never attempt to make any measurement if any abnormal conditions are noted, such as broken case and exposed metal parts or when inner jackets are seen through the nicked outer jacket.
- Do not rotate the Range switch with the test leads connected to the equipment under test.
- Do not install substitute parts or make any modification to the instrument. Return the instrument to your local Kyoritsu distributor for repair or recalibration.
- Do not try to replace the battery if the surface of the instrument is wet.
- Firmly insert the plug into the terminal when using test leads.
- Ensure that the instrument is powered off when opening the battery compartment cover for battery replacement.

CAUTION

- Always make sure to set the Range switch to the appropriate position before making a measurement.
- Set the Range Switch to “OFF” position after use and disconnect the test leads from the instrument. Remove the battery if the instrument is to be stored and will not be used for a long period.
- Do not expose the instrument to the direct sun, high temperature and humidity or dewfall.
- Use a cloth dipped in alcohol for cleaning the test leads and the part around the measuring terminals.
- Do not store the instrument if it is wet.
- The Voltage warning mark is being displayed during a measurement and it flashes when voltages 30V(DC/AC) or more exist on the circuit under test.

Symbols

	Danger of possible electric shock
	Instrument with double or reinforced insulation
	DC
	AC
	Earth terminal
	Crossed-out wheel bin symbol (according to WEEE Directive: 2002/96/EC) indicating that this electrical product may not be treated as household waste, but that it must be collected and treated separately.

○ Measurement categories(Over-voltage categories)

To ensure safe operation of measuring instruments, IEC 61010 establishes safety standards for various electrical environments, categorized as O to CAT.IV, and called measurement categories. Higher-numbered categories correspond to electrical environments with greater momentary energy, so a measuring instrument designed for CAT.III environments can endure greater momentary energy than one designed for CAT.II.

- O : Circuits which are not directly connected to the mains power supply.
- CAT.II : Electrical circuits of equipment connected to an AC electrical outlet by a power cord.
- CAT.III : Primary electrical circuits of the equipment connected directly to the distribution panel, and feeders from the distribution panel to outlets.
- CAT.IV : The circuit from the service drop to the service entrance, and to the power meter and primary overcurrent protection device (distribution panel).

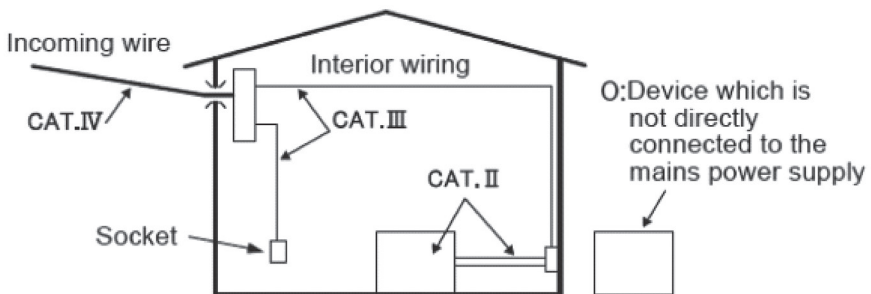

2. Feature

KEW3127 is a microcomputer controlled, high voltage insulation resistance tester with 5-range for measuring insulation resistance.

- Designed to following safety standards:
 - IEC 61010-1 (CAT. IV 600V Pollution degree 2)
 - IEC 61010-031 (Requirements for hand-held probes)
- With auto-discharge function
 - When insulation resistance like a capacitive load is measured, electrical charges stored in capacitive circuits are automatically discharged after measuring. Discharge can be checked on the voltage monitor.
- Backlight function to facilitate working at dimly illuminated location or at nighttime work.
- Bar graph to display measured result
- LIVE circuit warning symbols plus audible warning
- With Auto-power off function
 - To prevent the instrument being left powered on and conserve battery power, the instrument automatically turns off approx. 10 min. after the last switch operation.
- Auto-measurement and display of PI (Polarization Index), DAR (Dielectric Absorption Ratio) and DD (Dielectric discharge), Step Voltage (SV), leakage current and capacitance measurements, and Ramp measurement for breakdown voltage check.
- Filter function to reduce the variations in readings due to external influences
- With a short current of max 5mA, quick measurement is possible even if the object under test has capacitive components.
- Internal saved data and real-time measuring data can be transferred to a PC via Bluetooth communication or by using special USB adapter (MODEL8212 USB). Easy settings for KEW3127 and data analysis via PC are possible with the application software.

3. Specification

● Applicable standards

IEC 61010-1 Measurement CAT. IV 600V Pollution degree2

IEC 61010-031 Standard for hand-held probes
 MODEL7165A(CAT. IV 600V)
 MODEL7224A(CAT.IV 600V)
 MODEL7225A(CAT.IV 600V)

* When KEW3127 and the test lead are combined and used together, whichever is lower category either of them belong to is applied.

IEC 61326-2-2 EMC standard

IEC 60529 IP40(Instrument)

IP65 (Hard case)

● Measuring range and accuracy (Temperature, humidity: 23±5C°, 45 - 75%RH)
 <Insulation resistance tester>

Rated voltage	250V(*1)	500V	1000V	2500V	5000V	Accuracy
Measuring range(*2)	0.0-99.9MΩ	0.0-99.9MΩ 100-999MΩ	0.0-99.9MΩ 100-999MΩ 1.00-1.99GΩ	0.0-99.9MΩ 100-999MΩ 1.00-9.99GΩ 10.0-99.9GΩ	0.0-99.9MΩ 100-999MΩ 1.00-9.99GΩ 10.0-99.9GΩ	±5%rdg ±3dgt
	100-999MΩ 1.00-9.99GΩ	1.00-9.99GΩ 10.0-99.9GΩ	2.00-9.99GΩ 10.0-99.9GΩ 100-199GΩ	100-999GΩ	100-999GΩ 1.00-9.99TΩ	±20%rdg
Display range	0.0M - 12.00GΩ	0.0M-120.0GΩ	0.0M-240GΩ	0.0M-1200GΩ	0.0M-12.00TΩ	/
Open circuit voltage	DC 250V +10%, -10%	DC 500V +20%, -10%	DC 1000V +20%, -0%	DC 2500V +20%, -0%	DC 5000V +20%, -0%	
Rated current			1mA or more, 1.2mA or less (at 1MΩ load)	1mA or more, 1.2mA or less (at 2.5MΩ load)	1mA or more, 1.2mA or less (at 5MΩ load)	
Short-circuit current	For 10 sec after a test is started : max 5mA, after that : 1.4mA					

(*1) 250V Range is for IR_{PI/DAR} measurement only.

(*2) Measuring range goes to one lower range when the applied input drops to 80% or lower of the rating of the lower range. Measurement accuracy to be applied is changed when the range goes to the lower range.

<Voltage monitor for insulation resistance range>

Rated voltage	250V	500V	1000V	2500V	5000V	Accuracy
Measuring range	30-330V	30-650V	30-1200V	30-3000V	30-6000V	±10%rdg±20V (resolution 10V)

This monitor is used to check whether electrical charge stored on the equipment under test is discharged or not. The measured voltage value displayed on the LCD is a reference value.

Please be noted that the indicated value, when external AC voltage is applied to the instrument, is not the correct value.

<Volt meter >

	Measuring range	Resolution	Accuracy
Volt	DC voltage:±30 - ±600V AC voltage: 30 - 600V (50/60Hz)	1V	±2%rdg±3dgt
	Frequency	45.0-65.0Hz(*1)	0.1Hz
			±0.2Hz

(*1)When the measured voltage is less than 30V or DCV is measured, the frequency is displayed as “----Hz” on the LCD.

<Ammeter (Output Current)>

Measuring range	Accuracy
0.00nA~5.50mA	±10%rdg(*1)

(*1)If result of resistance measurement is 10MΩ or more, output current is determined by resistance and voltage.(Accuracy is derived from measured resistance specification and measured voltage specification)

<Capacity meter>

Rated voltage	Measuring range	Accuracy
250V ~ 2500V range	5.0nF ~ 50.0 μF	±5%rdg±5dgt
5000V range	5.0nF ~ 25.0 μF	

【Calculated Value】

PI,DAR,DD

Measurement Mode	Display range	Computational error
PI	0.00 ~ 9.99	±2dgt
DAR	0.00 ~ 9.99	±2dgt
DD	0.00 ~ 9.99	±2dgt

- Display: Liquid crystal display
Bar graph: Max. 41points
DAR/PI value: 9.99
Time: 99:59
- Low battery warning: Battery mark display (in 4 levels)
- Overrange indication: “OL” mark appears at insulation resistance range and “Hi” mark at voltage range.
- Auto-ranging: Range shifts to upper range : 1000 counts
Range shifts to lower range : 80 counts
(Only at the insulation resistance range)
- Auto-power-off: Power off function operates in 10 min. after the last switch operation.
- Used location: altitude 2000 m or less
- Temperature & humidity range (guaranteed accuracy):
23°C±5°C/Relative humidity 85% or less
(no condensation)
- Operating temperature & humidity range:
0°C to 40°C/Relative humidity 85% or less
(no condensation)
- Storage temperature & humidity range:
-20°C to +60°C/Relative humidity 75% or less
(no condensation)
- Overload protection: Insulation resistance range: AC1200V/10sec.
Voltage range: AC720V/10sec.
- Withstand voltage: AC6720V(50/60Hz)/5sec.
(Between electrical circuit and enclosure)
- Insulation resistance: 1000MΩ or more/DC1000V
(Between electrical circuit and enclosure)
- Dimension: 208(L)×225(W)×130(D)mm
(Hard case 380(L)×430(W)×154(D)mm)
- Weight: 4kg approx. (including battery)
Total 8kg approx. (including accessories)
- Power source: Rechargeable battery
12V5Ah Lead acid batteries (PXL12050) or equivalent.
- Power Adapter for recharging: Output:DC15V(15VA)
Input:100-240V 50/60Hz

●Current consumption (representative values at 12V of supply voltage)

Range	250V	500V	1000V	2500V	5000V	VOLT
Output at short-circuit	For 10 sec after a test is started : 700mA, after that : 180mA					110mA
When rated measuring current is outputted	380mA /0.25M Ω	440mA /0.5M Ω	510mA /1M Ω	670mA /2.5M Ω	860mA /5M Ω	
Output at open circuit	60mA	60mA	70mA	90mA	140mA	
On stand-by	30mA					
When backlight is on	Increased by 30mA					

Note) Current values in above table are all approximate values.

●Operating time: approx. 10 hours continuous

- under a load of 100M Ω at 5000V Insulation resistance range

●Accessories:

Line probe: MODEL7165A

(Including MODEL8255 Straight type prod with molded parts)

Earth cord: MODEL7224A

Guard cord: MODEL7225A

Hard Case MODEL9171

Pickel Type Prod: MODEL8019

Straight Type Prod: MODEL8254

Instruction manual

Power Adapter

●Optional accessories: USB Communication set:MODEL8258

(USB adaptor(MODEL8212USB) with KEW Windows for 3127)

Adaptor for recorder:MODEL8302

Line probe with alligator clip:MODEL7168A

Long Line probe with alligator clip (15m): MODEL7253

4. Instrument layout

4-1 Instrument layout

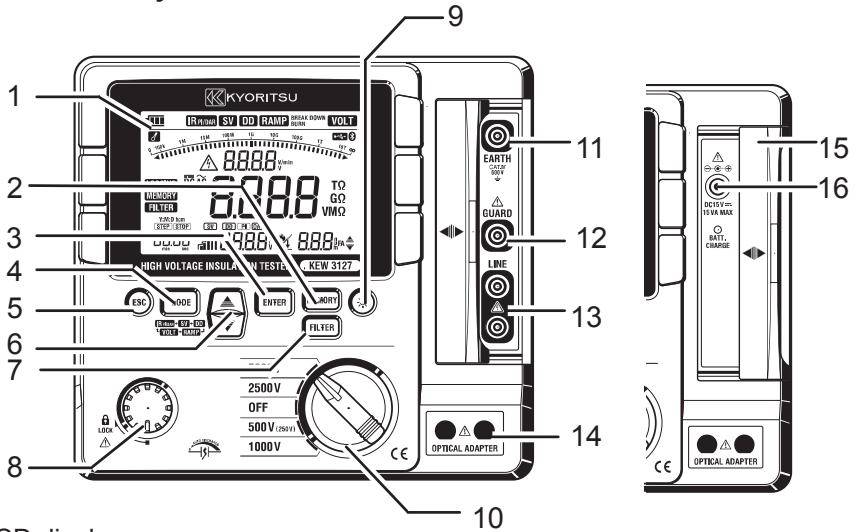

- 1 LCD display
- 2 MEMORY button
- 3 ENTER button
- 4 MODE button
- 5 ESC button
- 6 UP/DOWN button
- 7 FILTER button
- 8 TEST button
- 9 Backlight button
- 10 Range switch
- 11 Earth terminal
- 12 Guard terminal
- 13 Line terminal
- 14 Communication port
(for MODEL8212USB)
- 15 Shutter
- 16 Power adapter terminal
- 17 Earth cord (black)
- 18 Guard cord (green)
- 19 Line probe (red)
- 20 Power adapter

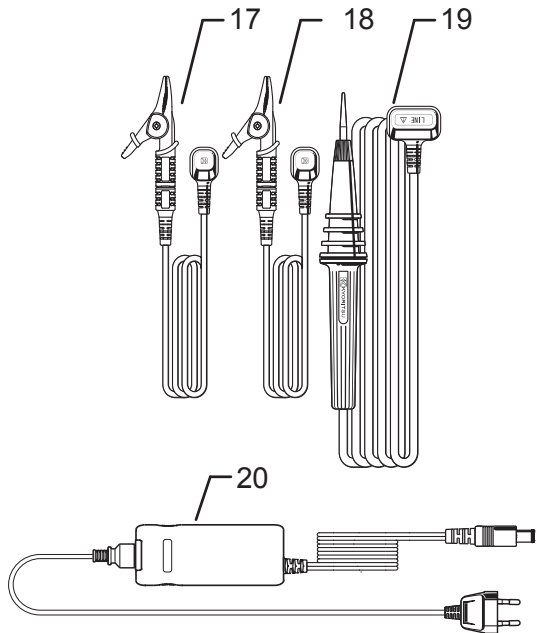

4-2 LCD display

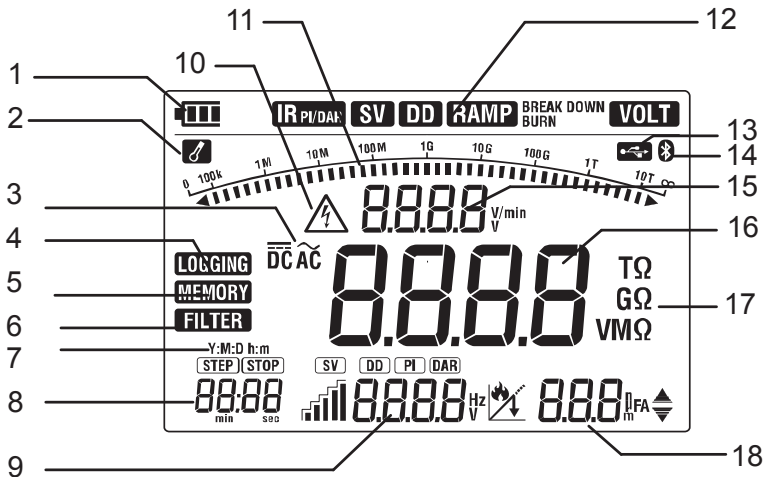

- 1 Battery mark
- 2 Overheat warning mark
- 3 AC/DC mark
- 4 LOGGING mark
- 5 MEMORY mark
- 6 FILTER mark
- 7 Date and time mark
- 8 Time
- 9 DAR/PI/DD/Break down/Frequency value
- 10 Voltage warning mark
- 11 Bar graph
- 12 MODE mark
- 13 USB mark(for MODEL8212USB)
- 14 Bluetooth mark
- 15 Output voltage
- 16 Insulation resistance
- 17 Unit
- 18 Capacitance / Output current value

4-3 Opening and closing Hard case

The Latching device has two features: the larger portion which is the latch itself ①, and the small latch release tab ② at the bottom of the latch.

1. To open, pull up the latch release tab ② in the direction of the arrow.
2. To close, lower the latch ① and press until it snaps.

Never press the latch release tab ② to close the latch as damage may result.

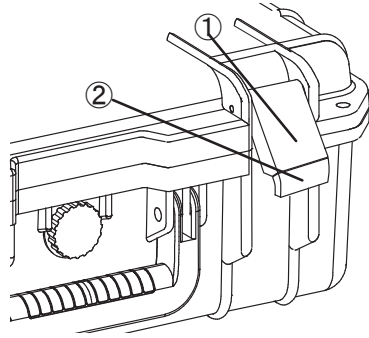

4-4 Taking out KEW3127 from the Hard case.

Grip the handles and pull upward to take out KEW3127 from the Hard case.

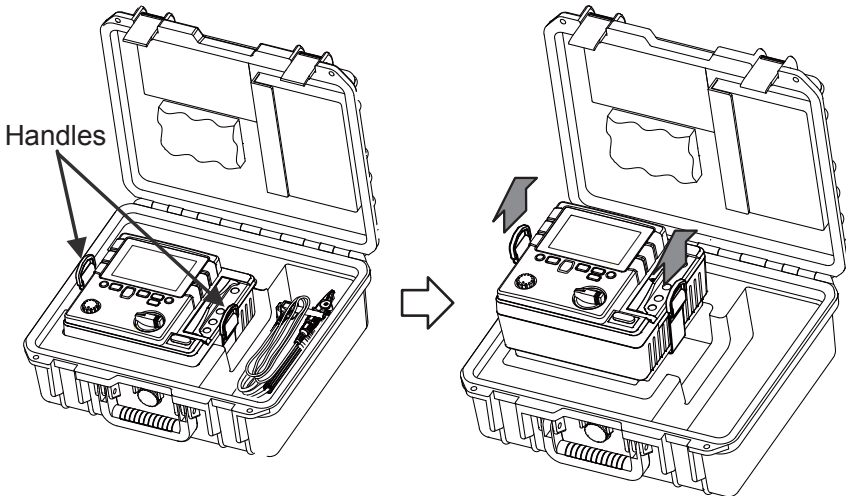

5. Preparation for measurement

It is recommended to charge the battery with reference to “10.1 How to charge battery” described in the manual before stating to use with the instrument since the battery voltage may be low due to self-discharge.

5-1 Checking the battery voltage

- (1) Set the Range switch to any position other than “OFF” .
- (2) When the battery mark shown at the upper left on the LCD is last 1 level  , the batteries are almost exhausted.

Charge battery to perform further measurements.

The instrument operates properly even in such a low battery power condition and it may not affect the accuracy.

When battery mark is empty  , the battery voltage is below the lower limit of the operating voltage. In such a condition, the accuracy isn't guaranteed.

Refer to “10.1 How to charge battery” and charge battery.

5-2 Connecting test leads

Insert the test lead firmly to the connector terminal on the instrument. Connect the Line Probe(red) to the Line terminal, the Earth Cord(black) to the Earth terminal and the Guard Cord(green) to the Guard terminal. (To establish guard is not necessary, you do not have to connect the Guard cord.)

DANGER

- Do not press the TEST button when the Range switch is at any position other than “OFF” . High voltages are applied to the test leads and you may get electrical shocks.

6. Measurement

6-1 Mains disconnection check (Voltage measurement)

⚠ DANGER

- Do not make measurement on a circuit in which the electric potential exceeds 600V (voltage to ground) in order to avoid getting electrical shock. In addition, do not use this instrument when the voltage to ground is 600V or higher even the line voltage is 600V or less.
- Ensure that a measurement is performed at the secondary side of the circuit breaker when testing the voltages of power lines, which has a large current capacity, in order to avoid possible hazard to the user.
- Extra precaution shall be taken to minimize the possibility of shorting the power line with the metal tip of test lead at voltage measurement. It may cause personal injury.
- Do not start a measurement with the battery cover removed.
- Connect the Earth cord (black) to the Earth terminal of the circuit under test.

Set the Range switch to any position other than “OFF” position.

Press the MODE button() and select “VOLT” mode.

No need to press the Test button.

KEW3127 has an AC/DC auto-detect circuit and can measure DC voltage as well.

At DC voltage measurement, when applying positive voltage to the Line Probe (red), positive value is displayed on the LCD.

Ensure that the circuit breaker of the circuit under test is turned off.

- (1) Connect the Earth Cord (black) to the earth side of the circuit under test and the Line Probe (red) to the line side respectively.
- (2) Confirm that the voltage displayed on the LCD is “Lo” . If the display doesn't show “Lo” , voltage is applied on the circuit under test. Check the circuit under test again and turn off the circuit breaker.

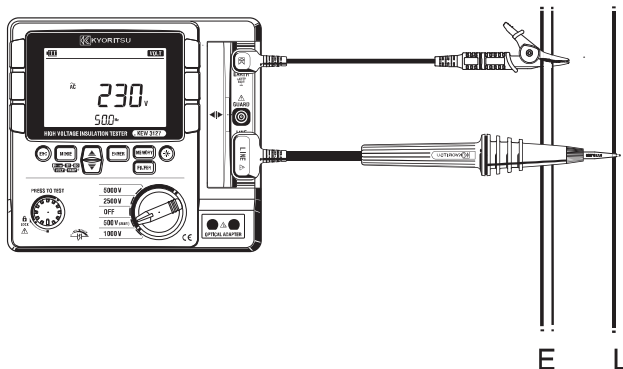

6-2 Insulation resistance measurement

⚠ DANGER

- Confirm that no electrical charge exists on the circuit under test before measuring by using a high voltage detector.
- Put on a pair of insulated gloves for high voltage.
- In case the Range switch is set to Insulation resistance range, high voltage is being applied to the tips of test leads and to the circuit under test continuously while the Test button is kept pressed down. Be extremely careful not to get electric shock.
- Do not start measurement with the battery cover removed.
- Never start measurement when thunder rumbling.
- Connect the Earth Cord (black) to the earth terminal of the circuit under test.
- When any mode other than VOLT mode is selected, live circuit warning symbol appears on the LCD and the audible warning activates when a voltage of 30V or higher is measured.

KEW3127 doesn't start a test, even the Test button is pressed down, if the measuring voltage is 160V or higher: it starts a test if the measuring voltage is under 160V upon a press of the Test button.

Prior to testing, ensure that the equipment under test is disconnected from the mains supply and not energized in order to avoid possible electrical hazards. This instrument may start a measurement for energized electrical circuits. Be extremely careful not to get electrical shock.

To check the insulation of electric equipments or electric circuits, measure their insulation resistances by using this instrument. Ensure to check the appropriate voltages to be applied to the equipment under test before starting a measurement.

Note)

- KEW3127 may show unstable readings when the insulation resistance of the equipment under test is not stable.
- Beep sound may be heard during insulation resistance measurement. But it is not malfunction.
- It takes time to measure a capacitive load.
- At insulation resistance measurement, positive (+) voltage is outputted from the Earth terminal and negative (-) voltage is outputted from the Line terminal. Connect the Earth cord to the Earth (ground) terminal.
It is recommended to connect the positive(+) pole to the earth side when measuring insulation resistance against the ground or when a part of the equipment under test is earthed.
With this connection, smaller measured value can be obtained comparing with other way round.

(1) Check the appropriate voltages to be applied to the circuit under test, and set the Range switch to any desired insulation resistance range.

(2) Press the MODE button () and select any of the following modes.

Mode	Details
IR _{PI/DAR}	Performs normal insulation resistance measurements (consistent measurements) (Auto-measurement and display of PI and DAR.)
SV	Increases the set voltage by 20% every time when pre-set time comes.
DD	Calculates dielectric discharge based on the measured capacitance of the measured object and residual current values after testing.
RAMP	Increases the preset voltage gradually to detect insulation failures.

- (3) Connect the Earth cord (black) to the Earth terminal of the circuit under test.
- (4) Put the tip of the Line probe (red) to the circuit under test.

Then press the Test button. The buzzer sounds intermittently during measurement when a range other than 500V(250V) range is selected.

- (5) The measured value will be displayed on the LCD, and it remains displayed on the LCD after a measurement.

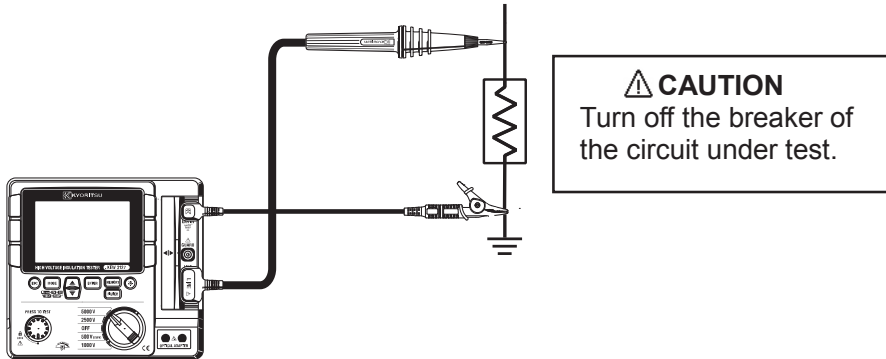

- (6) This instrument has Auto-discharge function. Keep the test leads connected to the circuit under test and release the Test button when measurements end. The auto-discharge function operates to discharge the electrical charges on the circuit under test. Confirm that the voltage monitor shows 0V.

⚠ DANGER





- Do not touch the circuit under test immediately after testing. Capacitance stored in the circuit may cause electric shock.
- Leave test leads connected to the circuit and never touch the circuit until the discharge completes.

Auto-discharge function

This is a function to discharge capacitance stored in the circuit under test automatically after testing. Discharge condition can be checked on the voltage monitor. This function will be canceled when removing the test leads 2 sec. or more before discharge completes.

(7) Set the Range switch to “OFF” position, and remove test leads from the instrument.

Note)

- The voltage warning mark stays on during a measurement and it blinks when voltages of AC/DC 30V or higher exist on the circuit under test.
- When measuring low resistances (if currents larger than the rated current are output) over a long period of time, KEW3127 consumes large power and will overheat. When this happens, further tests are automatically inhibited and the over-temperature symbol  appears on the display. The instrument must then be left cool down. Testing shall be resumed when  symbol disappears. Short-circuit currents at a start of measurement may get lower when the  symbol appears.
- Depending on the ambient temperature or measured resistances, the  symbol may appear and interrupt a PI measurement.

Principle of Insulation Resistance Measurement

Resistance value can be obtained by applying a certain high voltage to the resistance (insulation resistance) and measuring the flowing current.

$$\text{Resistance value} = \text{Voltage} / \text{Current}$$
$$(RX = V / I)$$

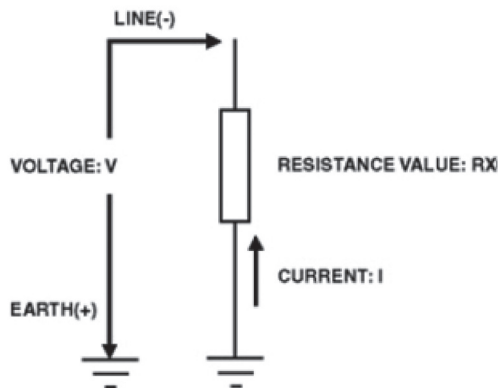

6-3 About BREAKDOWN mode and BURN mode

Either Breakdown mode or Burn mode can be set for each measurement: IR_{PI/DAR}, SV, DD, RAMP.

(1) Breakdown mode

When applied voltage decreases drastically due to breakdown or current sudden increase caused by insulation degradation, KEW3127 stops measurement automatically so as not to develop further damage.

KEW3127 continues measurement until an event of breakdown or current sudden increase is detected.

(2) Burn mode

When Burn mode is selected, KEW3127 continues measurement even if breakdown or current sudden increase event occurs. Keep checking the damage degree of the breakdown point and find the insulation failure point. Testing performed in Burn mode is destructive.

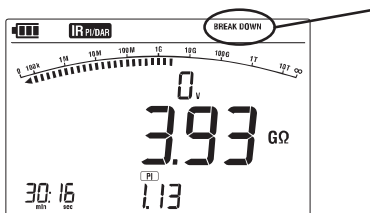

When breakdown occurs and measurement stops, breakdown mark blinks.

- When 250V Range has been selected, it is unable to select the Breakdown mode.

6-4 Continuous measurement

Press down and turn the Test button clockwise to lock it to perform a continuous measurement of insulation resistance. After testing, turn the button counterclockwise and set it to the initial position.

 **DANGER**

- Be extremely careful not to get electric shock as high voltage is present on the tip of test leads continuously.

6-5 IR_{PI/DAR} Measurement

At IR_{PI/DAR} measurement, PI/ DAR values are automatically calculated and displayed. During a measurement, values of current being measured and capacitances measured at discharging after measurement are displayed.

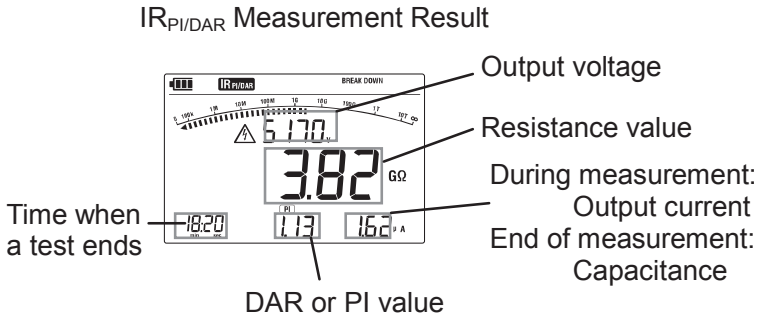

(1) Setting items

Setting items for IR_{PI/DAR} are as follows.

- Measurement duration:
Measurement automatically stops when the preset time period passes.
- Output voltage :
For 2500V/ 5000V Range, voltage value is adjustable to – 20% of rated voltage, can be set by 5%.
For 500V (250V) Range, either 500V or 250V is selectable.
- Breakdown/ Burn :
Either Breakdown or Burn mode is selectable. (For 250V, Burn mode only)

(2) Setting procedures

Follow the procedures below

[Stand-by state]

↓ ENTER button (ENTER)

Setting of Measurement duration (with UP/DOWN button (▲▼))

↓ ENTER button (ENTER)

Setting of Output voltage*1 (with UP/DOWN button (▲▼))

↓ ENTER button (ENTER)

Setting of Breakdown/Burn (with UP/DOWN button (▲▼))

↓ ENTER button (ENTER)

Setting is finished.

(*1): 500V/2500V/5000V Range only

6-5-1 PI – Polarization index

This is to check a temporal increase of leakage currents flowing on insulations and to confirm leakage currents aren't increased as time passes.

PI is usually determined by the insulation resistances measured 1 min and 10 min after a measurement is started. PI is dependent on the shape of insulations and influenced by moisture absorption, therefore, a check of PI is important to diagnosis the insulation of cables.

$$PI = \frac{\text{Insulation resistance (10 min after a start of test)}}{\text{Insulation resistance (1 min after a start of test)}}$$

PI	4 or more	4 - 2	2.0 - 1.0	1.0 or less
Criteria	Best	Good	Warning	Bad

6-5-2DAR - Dielectric Absorption Ratio

DAR measurement is almost same to PI measurement in a sense that they test the time course of insulation. The only difference is that DAR measurement can get result faster than the other.

$$\text{DAR} = \frac{\text{Insulation resistance (1 min after a start of test)}}{\text{Insulation resistance (15 or 30 sec min after a start of test)}^{*1}}$$

DAR	1.4 or more	1.25 - 1.0	1.0 or less
Criteria	Best	Good	Bad

Note1: DAR time is selectable: 15 or 30 sec.

How to select:

- ① Keep the MODE button (MODE) pressed down and rotate the Range switch to power on KEW3127. (DAR mark starts blinking.)
- ② Press the UP/DOWN button (▲▼) to switch 15 sec and 30 sec displayed at the lower left on the LCD. Select the desirable one.
- ③ Press the ENTER button (ENTER) and confirm the selection.

Selected DAR time is saved and kept after the instrument is powered off. To check the time currently selected, follow the step ① described as above.

6-5-3 How to measure DAR/ PI

DAR and PI are measured automatically at continuous measurement of IR_{PI/DAR} mode. Set the Range switch to any range and measure the test object continuously.

- 1 min after a start of continuous measurement:
LCD shows DAR value.
- 10 min after a start of continuous measurement:
LCD shows PI value.

When DAR/PI values are displayed as “---” :

DAR and PI values are determined by the methods 1. and 2. as described above, therefore, they are displayed as “---” when the measured insulation resistances fall under any of following cases.

① measured value is “0.0MΩ”

② measured value is “OL”

* “OL” is displayed when the measured value exceeds the upper limit of the measuring range at each insulation resistance range.

Range	Upper limit
250V	12GΩ
500V	120GΩ
1000V	240GΩ
2500V	1200GΩ
5000V	12TΩ

6-5-4 How DAR/ PI values are displayed

LCD shows DAR/PI values as shown below during measurements.

(1) Start of test

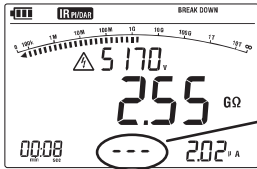

No DAR/PI value, " --- " is displayed.

(2) 1 min after the start of test

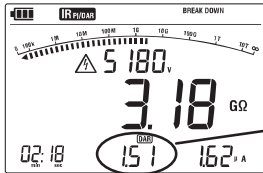

DAR value is displayed.

(3) 10 min after the start of test

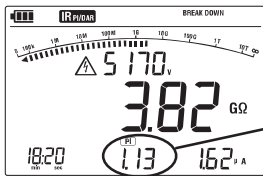

PI value is displayed.
Press the UP/DOWN button (▲▼) to switch DAR and PI values.

6-5-5 How to review the measured DAR/PI values

Press the UP/DOWN button (▲▼) when measurements end. The measured results are then displayed in following sequence. If the measurement ends earlier than the intervals described in below (2), (3) or (4), blank displays aren't shown and returns to (1).

(1) Start of test

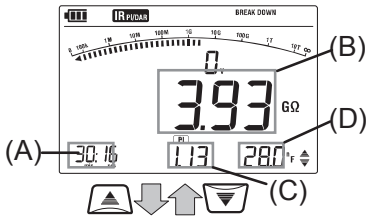

(A)	Time when a test ends
(B)	Value measured at the end of test (resistance value)
(C)	DAR or PI value
(D)	Capacitance

(2) 1 min after the start of test

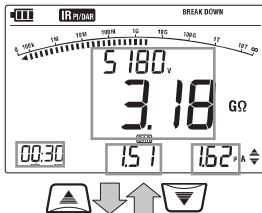

(2)	1 min after the start of test
(A)	Elapsed time (15 or 30 sec)
(B)	Value measured 15 or 30 sec after a start of test. (resistance value, output voltage)
(C)	DAR value
(D)	Output Current measured 15 or 30 sec after a start of test.

(3) 10 min after the start of test

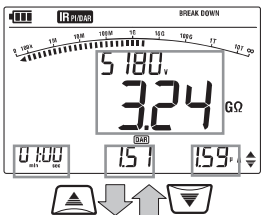

(A)	Elapsed time (1 min)
(B)	Value measured 1 min after a start of test. (resistance value, output voltage)
(C)	DAR value
(D)	Output Current measured 1 min after a start of test.

(4) Results at 10 min after a start of test

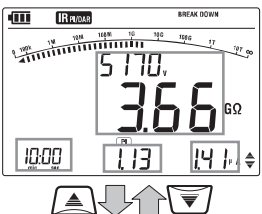

(A)	Elapsed time (10 min)
(B)	Value measured 10 min after a start of test. (resistance value, output voltage)
(C)	PI value
(D)	Output Current measured 10 min after a start of test.

Return to (1)

6-6 SV Measurement (Step Voltage)

This is a test based on the principle that an ideal insulation will produce identical readings at all voltages, while an insulation which is being over stressed, will show lower insulation values at higher voltages. During the test, the applied voltage incrementally steps by a certain voltage taking successive 5-time measurement. Degradation of insulation may be doubt when insulation resistances become lower at higher applied voltages.

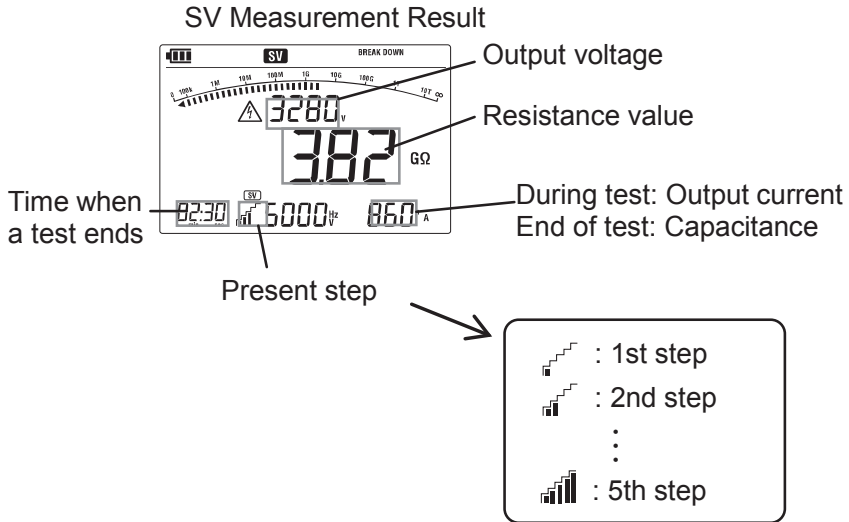

(1) Setting items

Setting items for SV measurement are as follows.

(For SV measurement, 250V cannot be set at 500V (250V) Range.)

- * Step time : Measurement duration per step.
- * Breakdown/ Burn : Either Breakdown or Burn mode is selectable.

Setting procedures
 Follow the procedures below.

[Stand-by state]

↓ ENTER button (ENTER)

Setting of Step time (with UP/DOWN button (▲▼))

↓ ENTER button (ENTER)

Setting of Breakdown/Burn (with UP/DOWN button (▲▼))

↓ ENTER button (ENTER)

Setting is finished.

6-7 DD Measurement (Dielectric Discharge)

This measurement method is usually used to diagnosis multi-layer insulations, which requires the instrument to measure the discharge current and capacitance of the measured object 1 min after the removal of the test voltage. This is a very good diagnostic insulation test that allows deterioration and other problems voids in the multiple insulations to be assessed.

$$\text{Dielectric Discharge} = \frac{\text{Current value 1 min after completing measurement (mA)}}{\text{Voltage value when a measurement Complete (V) x Capacitance (F)}}$$

DD	2.0 or less	2.0 - 4.0	4.0 - 7.0	7.0 or more
Criteria	Good	Warning	Poor	Very Poor

This criteria is a guide and could be slightly changed and be adapted to particular objects under test based on practical experience of the users. This method has been established to test high voltage generators installed in electric power plants in the Europe countries.

DD Measurement Result

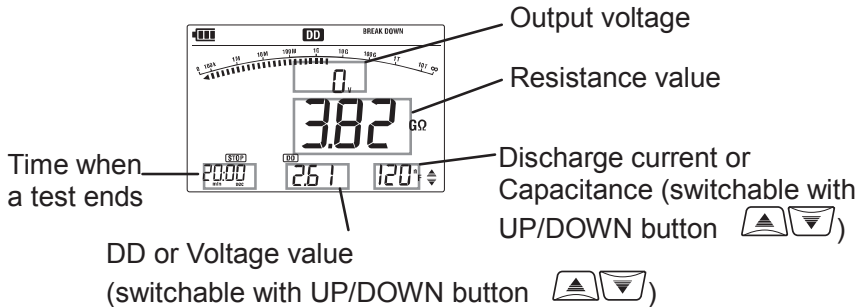

(1) Setting items

Setting items for DD measurement are as follows.

(For DD measurement, 250V cannot be set at 500V (250V) Range.)

* Step time : Measurement duration per step.

* Breakdown/ Burn : Either Breakdown or Burn mode is selectable.

(2) Setting procedures

Follow the procedures below.

[Stand-by state]

↓ ENTER button ()

Setting of Step time (with UP/DOWN button ())

↓ ENTER button ()

Setting of Breakdown/Burn (with UP/DOWN button ())

↓ ENTER button ()

Setting is finished.

6-8 Ramp Measurement

Voltage used in Step voltage test is raised in steps but that used in Ramp measurement is gradually raised. Therefore, Ramp measurement is useful to find the points of insulation failure without causing serious damages. This enables you to locate a fault, such as pinholes in windings, by seeing a spark or a wisp of smoke.

KEW3127 displays the breakdown voltage value when insulation breakdown occurs in load.

*** Breakdown mode**

When a breakdown occurs, KEW3127 stops measurement and displays the voltage which caused breakdown. When no breakdown is detected, voltage is raised till it reaches to the preset voltage value.

*** Burn mode**

KEW3127 continues measurement, even if a breakdown is detected, until applying voltage reaches to the preset value. Breakdown voltage will be displayed after a measurement.

Note: Ensure that the object under test is completely discharged before performing a Ramp measurement.

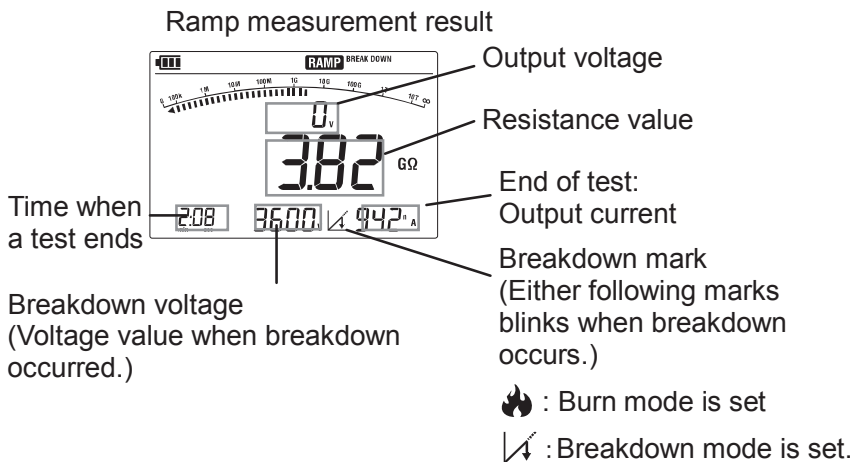

(1) Setting items

Setting items for RAMP measurement are as follows.

(For RAMP measurement, 250V cannot be set at 500V (250V) Range.)

* Speed of voltage rise: Voltage rise per minute.

* Breakdown/ Burn : Either Breakdown or Burn mode is selectable.

(2) Setting procedures

Follow the procedures below.

Output voltage rate can be set between 100V/min and 9000V/min.

[Stand-by state]

↓ ENTER button(ENTER)

Setting of Voltage rise speed (with UP/DOWN button(▲▼))

↓ ENTER button(ENTER)

Setting of Breakdown/Burn (with UP/DOWN button(▲▼))

↓ ENTER button(ENTER)

Setting is finished.

6-9 Voltage characteristics of measuring terminal

KEW3127 Output characteristics (IR_{PI/DAR} mode)

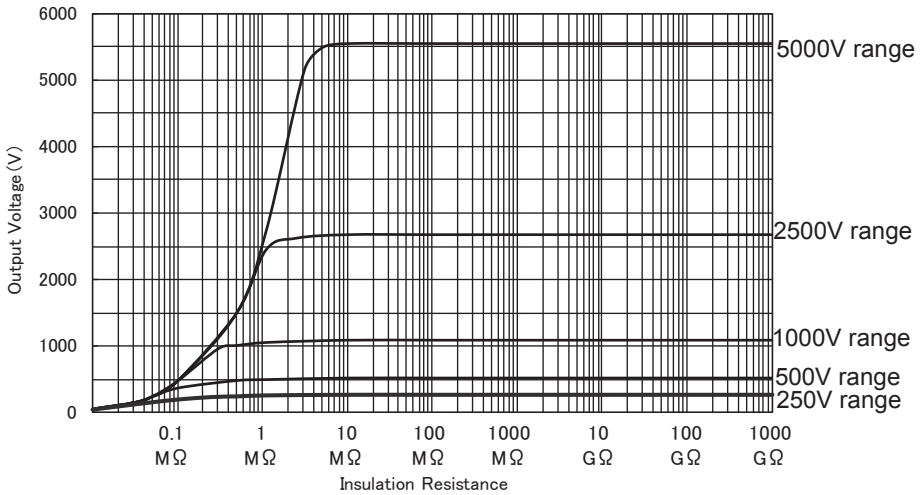

* for 10sec after a start of test

6-10 Use of Guard terminal

When measuring the insulation resistance of a cable, leakage current flowing on the surface of cable jacket and the current flowing inside the insulator are mixed and may cause error in insulation resistance value. In order to prevent such error, wind a conductive wire around the point where leakage current flows.

Then connect it to the Guard terminal as shown in the figure on the next page. This is to move out the surface leakage resistance of the cable insulation to measure only the volume resistance of insulator. Make sure to use the Guard cord supplied with this instrument to connect the instrument to Guard terminal.

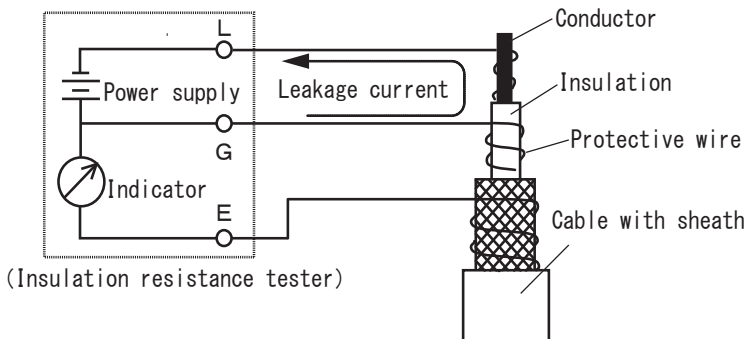

6-11 Filter function

KEW3127 has Filter function. Filter Mode is effective to reduce the variations in readings due to external influences during high resistance measurements. The filter type is Low pass filter with cut off frequency of 0.3Hz.

Press the FILTER button (FILTER) to enable the Filter function. The Filter mark then appears on the LCD. To check sudden variations in resistances, ensure that the Filter mode is turned off.

6-12 Backlight function

This function to facilitate working at dimly illuminated location or at nighttime work. The backlight doesn't work when the Range switch is set to "OFF". It automatically turns off 1 min after the last key operation; this feature is disabled while a measurement is processed.

6-13 Auto-power-off function

The instrument automatically turns off approx. 10 min. after the last switch operation. To restore from the auto power off status, set the Range switch to OFF position once and then set it to any desirable range.

7. Memory Function

7-1 Function Details

Measurement data of insulation resistance can be saved in the internal memory of KEW3127.

Following data can be saved.

1. LOGGING: Measuring data is saved every second.
2. MEMORY: Data is saved at the end of measurement.

(1) Max number of file

1. LOGGING: Max 10 files
* Up to 100min in total
* Max recording time per file: 90min
2. MEMORY: Max 32 files

(2) Parameters to be saved

Following parameters will be saved. (common for LOGGING and MEMORY)

1. In all modes: Saved time & date, measured values (resistance, current, voltage), capacitance
2. IR_{PI/DAR} mode: PI/ DAR value
DD mode: DD value
Ramp mode: Breakdown voltage

7-2 How to save data

Follow the procedures below to save the measured data.

Pressing the ESC button (ESC), during operation, returns to the previous screen.

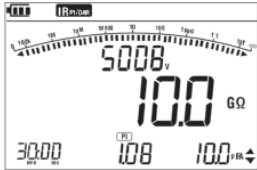

(1) Stand-by state

Data save in the MEMORY mode shall be done after finishing a measurement. (while the result is being displayed on the LCD.)

(2) Press the MEMORY button.

(3) Select either “MEMORY” or “LOGGING” with the UP/DOWN button (▲▼).



Blink



(4) Press the ENTER button.

When selecting “MEMORY” :

(5) Saving completes and back to stand-by state.

When selecting “LOGGING” :

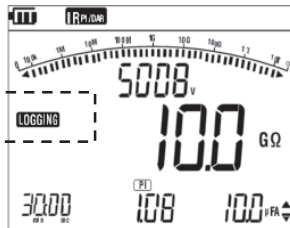

“LOGGING” mark appears

(5) Stand-by state

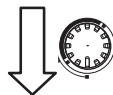

(6) Press the TEST button.

(7) Measurement and logging start.

7-3 How to recall saved data

Follow the procedures below to recall the saved data.

Pressing the ESC button (ESC), during operation, returns to the previous screen.

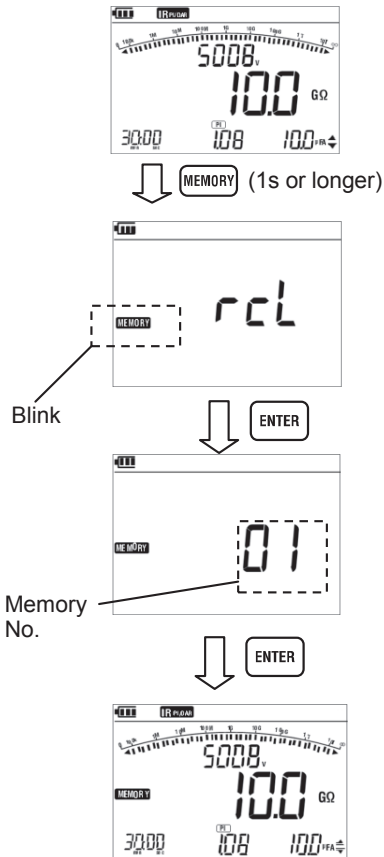

(1) Stand-by state

(2) Press the MEMORY button for 1 sec or longer.

(3) Select either “MEMORY” or “LOGGING” with the UP/DOWN button (▲▼).

(4) Press the ENTER button.

(5) Select a memory number with the UP/DOWN button (▲▼).

(6) Press the ENTER button.

(7) Saved data will be displayed. If the recalled data is logging data, the latest data will be displayed.

Press the UP/DOWN button (▲▼) to switch the display of current value and capacitance value.

7-4 How to delete data

Follow the procedures below to delete the saved data.

Pressing the ESC button (ESC), during operation, returns to the previous screen.

Recall and display the data which one wishes to delete. (See clause 7-3 How to recall the saved data.)

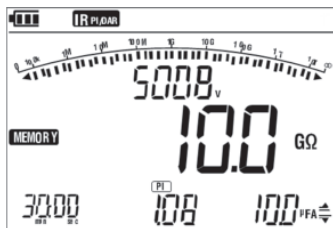

(1) Recall and display the saved data.

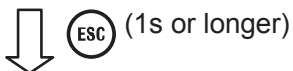

(2) Press the ESC button for 1 sec or longer.



(3) Confirmation screen is displayed.



(4) Press the ENTER button to delete the data.



(5) Return to Memory No. selection screen.

8. Clock Setting

Follow the procedures below and adjust the internal clock of KEW3127. To confirm the clock time, use the PC application “KEW Windows” or repeat the following steps.



[Power-off state]



(1) Hold down the ESC button and power on the instrument.

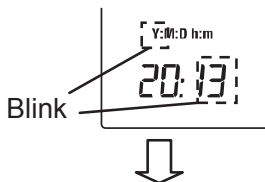





1. Adjust year.

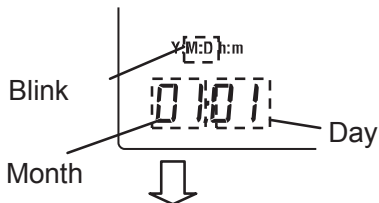

(2) At the lower left on the LCD, “Y” starts blinking. Adjust the year with the UP/DOWN button () , and then press the ENTER button ().





2. Adjust Month & day.

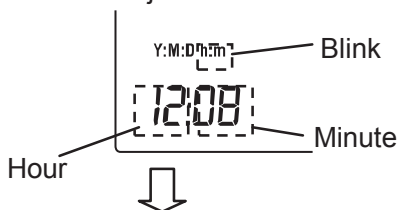

(3) Then” M:D” starts blinking. Adjust the month with the UP/DOWN button (), and then press the ENTER button (). Likewise, adjust day with the UP/DOWN button (), and then press the ENTER button ().

3. Adjust Hour & Minute.



(4) The last parameter,” h:m” starts blinking. Adjust hour with the UP/DOWN button (), and then press the ENTER button (). Do the same to set minute and press the ENTER button ().

4. Clock setting is finished.

(5) Now clock setting completes. Power off the instrument.

9. Communication Function/ Software

9-1 KEW3127 Settings

The PC software application enables analysis of the saved data from PC. KEW3127 has following two kinds of communication methods.

- (1)Bluetooth
- (2)MODEL8212USB

Following can be done via PC communication.

(use software KEW Windows for KEW3127.)

- * Downloading a file in the internal memory of the instrument to a PC
- * Making settings for the instrument via PC.
- * Displaying the measured results as a graph and saving them in realtime.

Communications with a PC cannot be established while operating KEW3127. (e.g.: while setting measurement time, output voltage or saving data.)

When the instrument is out of the range of Bluetooth or MODEL8212 USB is disconnected and the data download is failed, power off the instrument and on again and retry the download.

Instrument setting

Follow the procedure below and select the communication method on KEW3127 before starting PC communication.

1. [Power-off] state



2. [Setting]

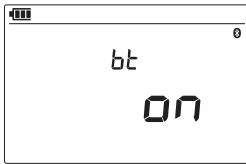

3. Setting is finished.

(1) Hold down the ENTER button and power on the instrument.

(2) LCD shows “BT on” . Use the UP/DOWN button (▲▼) and select a desirable communication method and press the ENTER button (ENTER).

* Selecting Bluetooth: set to “bt on”

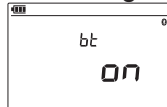

* Selecting MODEL8212USB: set to “bt off”

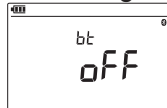

- When KEW3127 communicates via Bluetooth, Bluetooth mark (📶) is displayed on the LCD. When KEW3127 communicates via MODEL8212USB, USB mark (🔌) is displayed on the LCD.

● Using optional MODEL 8212 USB

- (1) Connect MODEL 8212 USB to the USB port on a PC. (Refer to the instruction manual for MODEL 8212 USB and install the special driver.)
- (2) Connect MODEL 8212 USB and KEW3127 as illustrated below. Further instructions for use are in the HELP for “KEW Windows for 3127” .

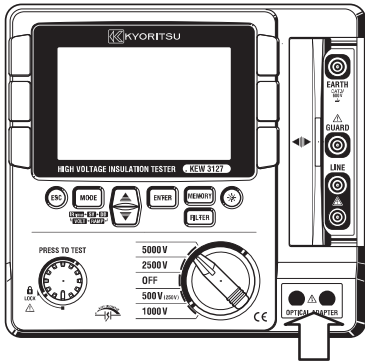

Connect MODEL 8212 USB here.

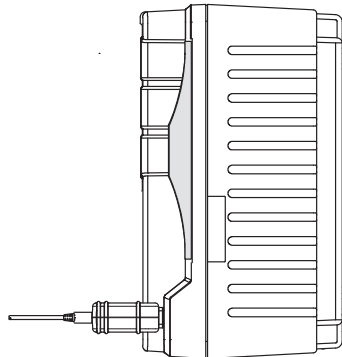

After connecting MODEL 8212 USB. (side view)

● Interface

(1) Bluetooth

Bluetooth Ver2.1+EDR (Class2)
Compliant profile: SPP

(2) MODEL8212USB

Communication method: USB Ver1.1

● Software

KEW Windows for KEW3127 (Download this software from our homepage. Refer to “9-2 How to install the Software” .)

● System Requirements

* OS (Operation System)

Windows7/VISTA/XP (CPU: Pentium 4 1.6GHz or more)

* Memory

512Mbyte or more (for Windows XP), 1Gbyte or more (for Windows 7/ Vista)

* Display

1024 × 768 dots, 65536 colors or more

* HDD (Hard-disk space required)

1Gbyte or more (including Framework)

* .NET Framework (3.5 or later)

● Trademarks

* Windows® is a registered trademark of Microsoft in the United States.

* Pentium is a registered trademark of Intel in the United States.

* Bluetooth is a registered trademark of Bluetooth SIG.

9-2 How to install the Software

Followings are the instructions to install the software “KEW Windows” and “KEW Windows for KEW3127” .

(1) Before installing the software, followings shall be checked.

- To prepare your system to install this software, please close all open programs.
- Be sure NOT to connect the instrument with USB until install is completed.
- Installation shall be done with administrative right.

(2) Download the file "KewWin3127Inst_eng.exe" from our homepage. (<http://www.kew-ltd.co.jp>)

(3) Run the "KewWin3127Inst_eng.exe".

Then following window appears. Click “Next”

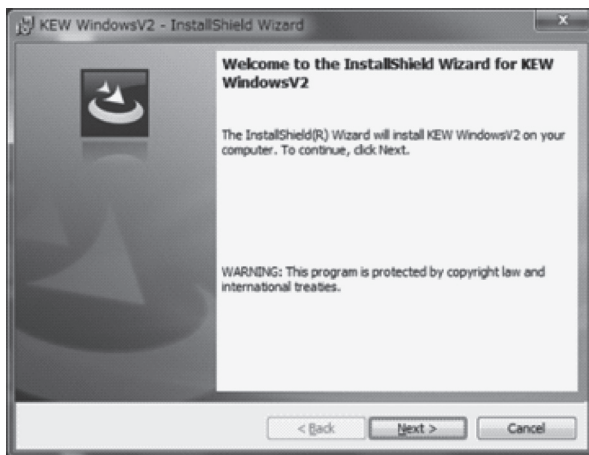

Read through and understand the License Agreement, and check “I accept....” . Then click “ Next” .

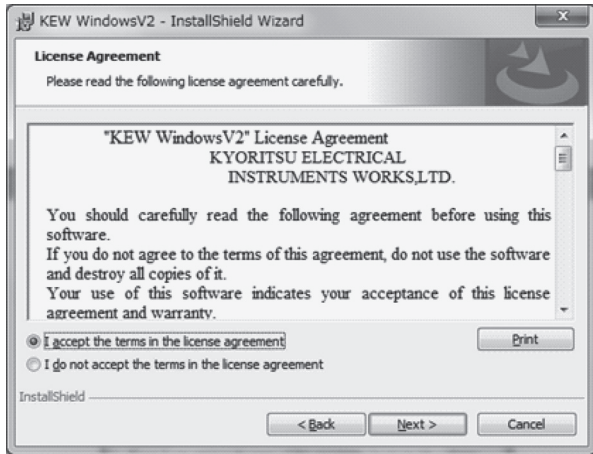

Enter the user information and specify the location to where install the software. Then click “ Next” .

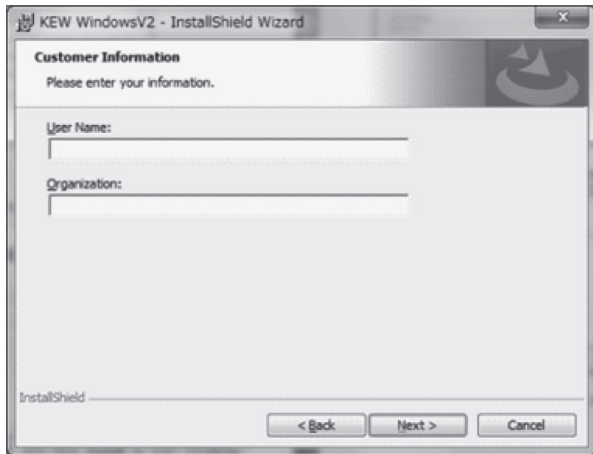

Confirm the information on install, and click “ Install” to start installing.

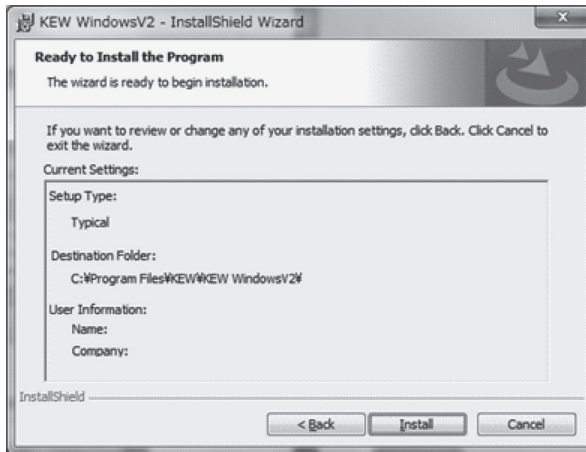

Click “Finish” when install completes.

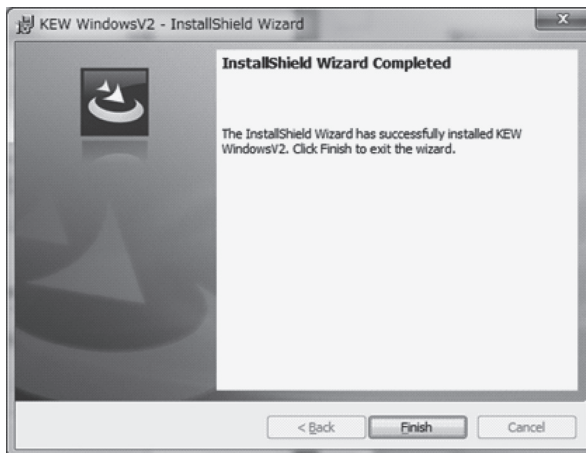

An installation of “KEW Windows for KEW3127” is followed by the installation of “KEW Windows” .



- To install the “KEW Windows for KEW3127”, you can follow the same installation procedure described for “KEW Windows”.

If you need to remove this software, use the “Add/Remove Programs” tool in the Control Panel.

9-3 How to start “KEW Windows for KEW3127”

- Start and Quit

Start the software by; 1) clicking the icon for [KEW Windows] on the desktop, or 2) clicking [Start] → [Program] → [KEW] → [KEW Windows]. Then the KEW products, which have been installed in the “KEW Windows”, are listed up. Select the “KEW3127” on the list, and then click “Next”. Then a main menu for “KEW Windows for KEW3127” appears. Click [Data Download] or [Instrument Setting].



9-4 Features of KEW Smart

Remote checking of measurements is possible without accessing KEW3127 using the special Android application “KEW Smart” .

The application “KEW Smart” is available on download site for free. (An Internet access is required.)

Please note that communication charge is incurred separately for downloading applications and using special features of them. For your information, “KEW Smart” is provided on-line only.

Main features:

- Checking of measurement
Measurements can be displayed in graphic or numeric forms on Android devices in real-time.
- Checking of KEW3127 setting
Settings of KEW3127 can be checked.
- Saving measured results
Results can be converted and saved in PDF.
- Transmitting measurement data
Saved data can be transmitted to a PC. Details can be found in the HELP for “KEW Smart” .

Cautions:

- Battery level of KEW3127 is not shown on Android devices. Ensure that the battery level of KEW3127 is sufficient before starting to perform measurements using these features. Charge battery if necessary.
- Remote control, such as switching ranges of KEW3127, from Android devices is not possible.

10. Battery Charging and Replacement

10-1 How to charge battery

DANGER

Use only the Power adapter supplied with this instrument.

Connect the Power adapter to a mains socket outlet. The mains supply voltage must not exceed AC240V.

Handling and storage instructions specified by the battery manufacturer should be observed.

WARNING

Never attempt to make any measurement if any abnormal conditions, such as a break on the Power adapter or exposed metal parts are present on the instrument. When unplugging the Power adapter from the mains socket outlet, do so by removing the plug first and not by pulling the cord.

- (1) Set the Range Switch to the OFF position.
- (2) Confirm a battery is installed in the instrument.
- (3) Slide the shutter of the terminal to the measurement terminal side and connect the Power Adapter.
- (4) LED Status Indicator flashes in red and the Battery Mark also flashes on the LCD.
- (5) The indicator lights up in green and the Battery Mark on the LCD stops flashing and lights up. (Battery charge completes in about 8 hours.)

* KEW3127 cannot perform measurement while charging battery.

* Battery life and how many times can be charged are depended on conditions of use and environment.

* Storing rechargeable lead-acid batteries in a low-charged state could lead to reduced life and/or damage. When storing the battery for a long period, check and charge the battery at regular intervals.

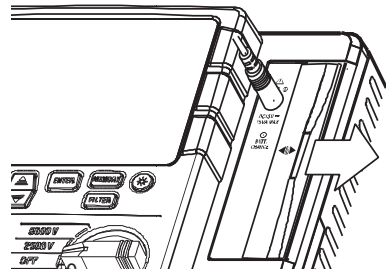

10-2 How to replace battery

⚠ DANGER

- Never open the battery compartment cover while making measurement.
- To avoid possible electric shock, disconnect the test lead and Power Adapter from the instrument before replacing battery. After replacing batteries, make sure to tighten up the screw for battery compartment cover.

⚠ WARNING

- Always use 12V5Ah Lead acid battery PXL12050 or equivalent.

⚠ CAUTION

- Install battery with correct polarity.
- Followings may cause battery liquid leak, heating, explosion or damage to Case resulting injury.
 - * short-circuiting the positive and negative terminals,
 - * putting close to fire, or
 - * disassembly or modification.

- (1) Set the Range switch to “OFF” position, and remove the test leads and power adapter from the instrument.
- (2) Unscrew and slide to remove the battery compartment cover on the side face of the instrument. (Match the arrow mark on the battery compartment cover with the engraved “OPEN” on the instrument case.)
Attention should be paid not to lose screws.

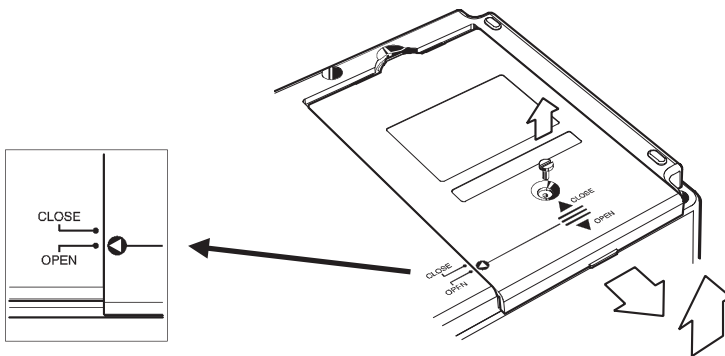

- (3) Pull up the battery as below and disconnect the red and black cables. (Pull the positive and negative connectors upwards and disconnect them from the battery.)

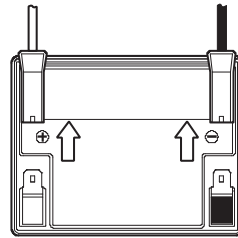
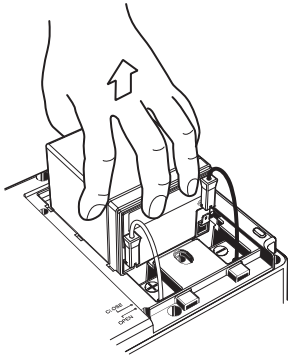

Pull the connector upwards.

- (4) Replace the old battery with the new one (lead-storage battery PXL-12050: 12V5Ah). Ensure that the connectors are properly attached and the metal terminals of battery are not deformed, and then install the battery observing the correct polarities.

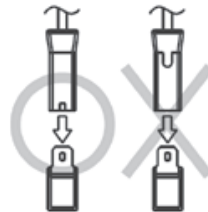
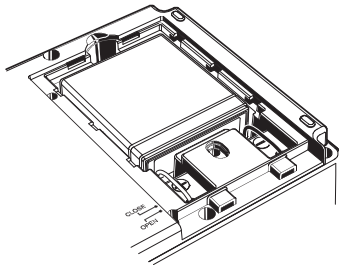

- (5) Slide and attach the battery compartment cover and tighten it with screw. Ensure that the arrow mark on the battery compartment cover matches with the “CLOSE” mark on the instrument case.

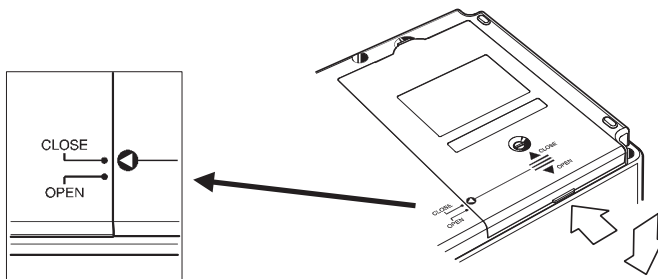

11.Accessories

11-1 Metal parts for Line Probe, and replacement

⚠ DANGER

In the electrical environment of CAT.II or higher, MODEL8255 should be attached and used with the test lead. With the large exposed metal parts of MODEL8254 and 8019, the equipment under test may be shorted. It may result in failure of the equipment under test and cause fire or lead to fatal or serious injury.

(1) Tip metal parts

MODEL8255: Standard Prod (straight type, with molded parts)

MODEL8254: Straight Type Prod

MODEL8019: Pickel Type Prod

To be used to hook the instrument.

(2) How to replace it

Turn the Line probe counterclockwise to remove the attached tip metal. Put the tip metal you want to use to the hexagon socket and turn it to clockwise together with the tip of probe, and tight up screws.

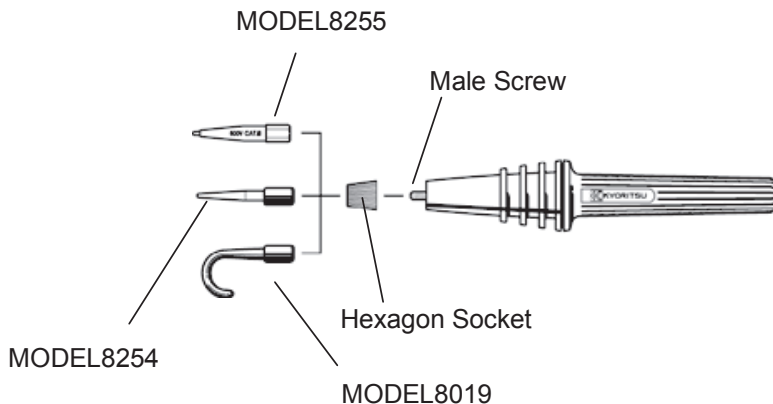

11-2 How to use the adaptor for recorder

MODEL8302 is the adaptor for recorder (option) for output current measurement. Connect it as shown in the below figure.

Output is DC1mA when current of $1\ \mu\text{A}$ is flowing.

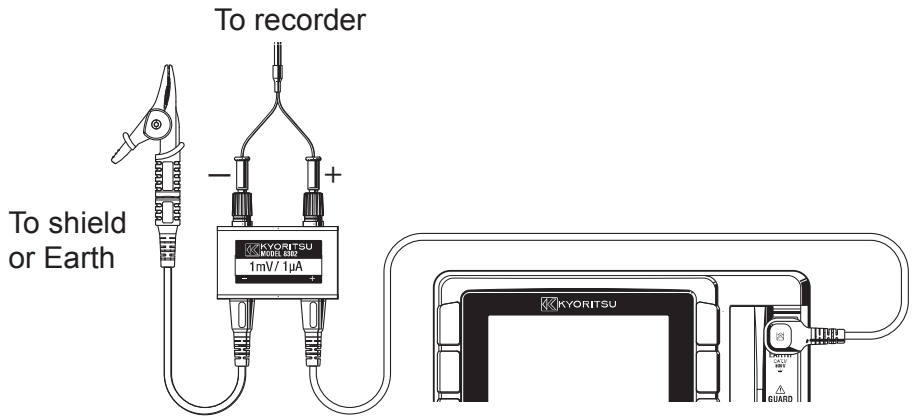

* MODEL8302 can measure currents up to 2mA.

11-3 Line probe with alligator clip(optional accessory)

(1) MODEL7168A Line probe with alligator clip

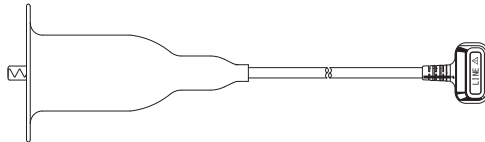

(2) MODEL7253 Long Line probe with alligator clip (15m)

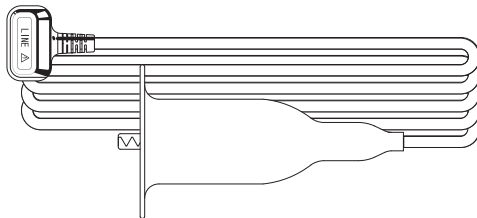

12. Disposing the Product

Waste Electrical and Electronic Equipment (WEEE), Directive 2002/96/EC

This Product complies with the WEEE Directive (2002/96/EC) marking requirement. The affixed product label (see below) indicates that you must not discard this electrical/electronic product in domestic household waste.

Product Category

With reference to the equipment types in the WEEE directive Annex 1, this product is classified as a “Monitoring and Control instrumentation” product.

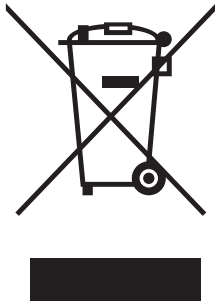

Disposing lead-storage batteries

When you throw away the batteries, be sure to cover their positive and negative terminals and always observe local laws and regulations.

Insufficient insulation of the terminals may cause explosion or fire because electrical energies remain in lead-storage batteries after use.

MEMO

MEMO

DISTRIBUTOR

Kyoritsu reserves the rights to change specifications or designs described in this manual without notice and without obligations.



**KYORITSU ELECTRICAL
INSTRUMENTS
WORKS, LTD.**

2-5-20, Nakane, Meguro-ku,

Tokyo, 152-0031 Japan

Phone: +81-3-3723-0131

Fax: +81-3-3723-0152

Factory: Ehime, Japan

www.kew-ltd.co.jp